

# Dictionary of Ship Hydrodynamics

(Alphabetic)



*Version 2008*

## INTRODUCTION

This Dictionary is intended for a broad readership including practising naval architects who wish to acquire and apply knowledge of hydrodynamics and also physicists and theoretical hydrodynamicists who wish to apply their particular knowledge to the solution of ship problems.

Engineering, physical and nautical terms in common use have not been included when they did not require special definition in the context of ship hydrodynamics or when their meanings were self evident. The terms are sorted alphabetically and for each term the context of its usage is given with the following signifiers:

*(cavitation)*

is defined as the process of formation of the vapour of liquid when it is subjected to reduced pressure at constant ambient temperature. It is used in the engineering context of liquid flow around bodies generally and, in particular, screw-propellers and hydrofoils.

*(general)*

Under this is listed a number of general terms frequently encountered in the field of naval architecture and marine engineering. To ensure that their general meanings are retained and that they are employed in the proper manner, their definitions are given here.

Also definitions or descriptions are given of a number of liquid properties and physical constants concerned of ship hydrodynamics.

*(hydrodynamics)*

is concerned with fundamental aspects of the resistance of a ship, or body, to motion through calm water without consideration on the effects of the method of propulsion.

*(manoeuvring)*

is used to define the quality which determines the ease with which the speed, attitude and di-

rection of motion of a ship or body can be changed or maintained by its control devices.

*(performance)*

is concerned essentially with performance in the context of power required to propel a ship at a given speed and various factors and matters related thereto. The propelling device is generally understood to be a screw propeller.

*(propulsor, propulsion)*

is concerned with propeller performance and various factor related thereto together with propeller geometry. Except where stated, the entries refer generally to screw propellers.

*(seakeeping)*

this section covers, in general, the behaviour and performance of a ship in a seaway including, in particular, ship motions and the sea states which cause them.

*(ship geometry)*

signifies ship and hull geometry generally.

The order of entry for each item is: title, symbol, and usage, dimensions, followed by the definition. In each section the titles re arranged in alphabetical order. In this way, having found the item required, perusal of the section will indicate other related items which may be of interest. For general reference, there is an overall alphabetical index of all titles and against each is given the section and page where the item is to be found.

The symbols given are in accordance with those in the latest ITTC list which is complementary document.

In a number of instances, the list give alternative symbols and these are generally included except where a definite preference is indicated.

# A

## Acceleration zone (cavitation)

In the sequence of cavitation erosion, the zone of the curve of weight loss versus time in which a rapid increase in weight loss occurs (the region between the *incubation zone* and the *deceleration zone* which see). Formerly called the *Accumulation zone*.

## Active rudder (propulsion, propulsor)

See: *Rudder, active*

## Added mass (seakeeping) [M]

The total hydrodynamic force, per unit acceleration, exerted on a ship or other body in phase with and proportional to the acceleration.

## Added mass coefficient (seakeeping) ( $A_{ij}$ ) [-]

A non-dimensional coefficient expressing *added mass* (which see) in  $i^{\text{th}}$  mode due to  $j^{\text{th}}$  motion.

## Admiralty coefficient (performance)

A quasi-dimensionless coefficient used for assessing or comparing the performance of ship.

Admiralty coefficient =  $\Delta^2 V^3 / P$ , where  $\Delta$  is the displacement,  $V$  speed and  $P$  any corresponding power.

## Advance (manoeuvring)

The distance by which the centre of gravity (CG) of a ship advances in the first quadrant of a turn. It is measured parallel to the approach path, from the CG position at rudder execute to the CG position where the ship has changed heading by 90 degrees (See Figure 7-1). Maximum advance is the distance, measured parallel to the approach path from the CG position at rudder execute to the tangent to the path of the CG normal to the approach path. The first of these terms is that most commonly used.

Figure 7-1: Geometry of turning circle

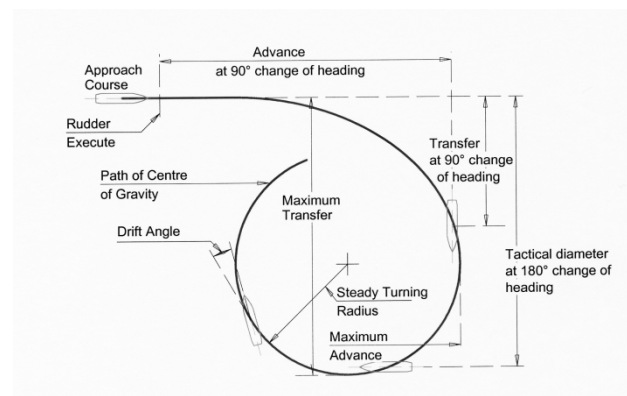

## Advance angle (of propeller blade section) (propulsion, propulsor)

See: *Angle, advance*

## Advance angle, effective (propulsion, propulsor)

See: *Angle, effective advance*

## Advance coefficient (propulsion, propulsor) ( $J$ ) [-]

A parameter relating the speed of advance of propeller,  $V_A$  to the rate of rotation,  $n$ , given by  $J = V_A / nD$ , where  $D$  is the propeller diameter. The advance coefficient may also be defined in term of ship speed,  $V$ , in which case it is given by:  $J_v = V / nD$ .

## Advance coefficient, Taylor's (propulsion, propulsor) ( $\delta$ )

A parameter defined as:

$$\delta = nD / V_A = 101.27 / J$$

where  $n$  is the rate of propeller rotation in revolution per minute,  $D$  is the propeller diameter in feet, and  $V_A$  is the speed of advance in knots.

**Advance maximum (in stopping)** (*manoeuvring*)

The distance travelled by a ship, in the direction of the approach path, before coming to rest after having executed a crash-back manoeuvre from a steady, straight-line motion ahead; it is also called *Headreach*. (See Figure 7-2). See also: *Transfer, maximum (in stopping)*.

Figure 7-2: Crash stop manoeuvre

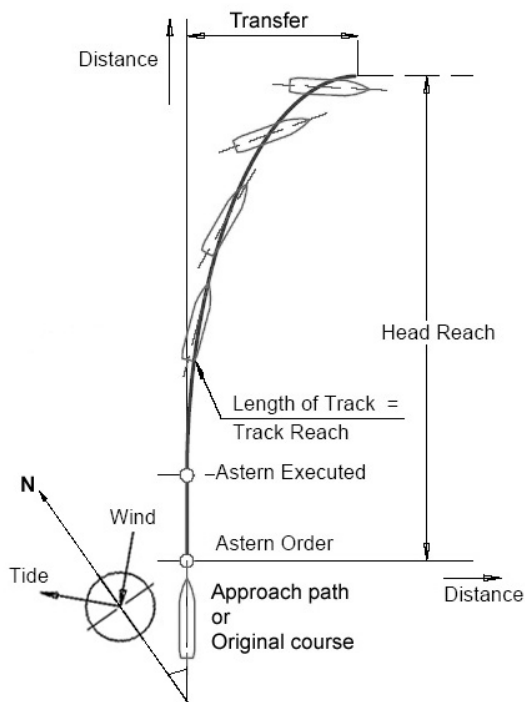

**Advance ratio** (*propulsion, propulsor*) ( $\lambda$ ) [-]

A non dimensional speed parameter relating the speed of advance,  $V_A$  and the rotational tip speed,  $\pi nD$ , given by:

$$\lambda = V_A / \pi nD = J / \pi$$

where  $J$  is the advance coefficient,  $D$  is propeller diameter and  $n$  its rate of rotation.

**Advance, speed of** (*propulsion, propulsor, performance*)

See: *Speed of advance*.

**Air content**(*cavitation*)

The term used loosely to describe *gas content* (which see) when gas content is composed of components of air in the liquid.

**Air content ratio**(*cavitation*)

See: *Gas content ratio*.

**Air, still, resistance** (*performance*)

See: *Resistance, wind*.

**Amidships** (*ship geometry*) (sometimes contracted to midship) ( $\text{\textcircled{O}}$ ) [-]

Near the centre of ship length, specially, the section of the ship at mid length (See Figure 2-12)

**Amplitude** (*seakeeping*)

Extreme value of a sinusoidal quantity with respect to the mean value.

**Analysis pitch** (*propulsion, propulsor*)

See: *Pitch, analysis*.

**Angle, advance (of a propeller blade section)** (*propulsion, propulsor*) ( $\beta$ ) [-]

The inflow angle to a propeller blade section determined by the rotative speed,  $\omega r$ , the axial velocity of the fluid,  $V_x$ , and the tangential velocity of the fluid  $V_\theta$ , according to the equation:

$$\beta = \tan^{-1}\{V_x(r, \theta) / [\omega r - V_\theta(r, \theta)]\}$$

$r$  is the radius of the blade section,  $\omega$  the angular rate rotation and  $\theta$  the angular position of the blade section.

A simpler definition, also in use is:

$$\beta = \tan^{-1}(V_A / \omega R)$$

where  $R$  is the propeller radius and  $V_A$  the advance speed.

The induced velocities are not included in the determination of the advance angle (See Figure 4-3).



**Angle, leeway** (*seakeeping*)  
See: *Drift or sideslip, angle of.*

**Angle, neutral** (*manoeuvring*)  
See: *Neutral angle.*

**Angle, pitch** (*manoeuvring, seakeeping*)  
See: *Pitch angle.*

**Angle, roll** (*manoeuvring, seakeeping*)  
See: *Roll angle*

**Angle, rudder** (*performance, manoeuvring*)  
See: *Rudder angle and Rudder angle ordered.*

**Angle of run** (*ship geometry*)  
See: *waterline*

**Angle, shaft** (*propulsion, propulsor*) [-]  
The angle or angles made by a shaft axis with the centre-plane and/or the baseplane of a ship. If a craft significantly changes attitude at speed, the shaft angle may, if so indicated, be measured between the shaft axis and the direction of motion.

**Angle, toe, of an offset rudder** (*manoeuvring*)  
The angle of a rudder, offset from the centre-plane, when in its zero lift or neutral position, it does not lie parallel to that plane. The rudder “toes in” when its forward portion points inward toward the centreplane. To avoid ambiguity the terms “trailing edge out” or “trailing edge in” are often used.

**Angle of trim** (*manoeuvring, seakeeping*)  
See: *Trim, angle of.*

**Angle, vertical path or angle, flight path** (*manoeuvring*) ( $\theta_i$ ) [-]  
The vertical angle between the underwater path of the centre of gravity of a submerged body or submarine in motion and horizontal plane through that centre. The path angle is a combination of the trim angle and the angle of attack.

**Angle of wave direction** (*seakeeping*)  
See: *Wave direction, angle of*

**Angle of wave encounter** (*seakeeping*)  
See: *Wave encounter, angle of*

**Angle, yaw** (*manoeuvring, seakeeping*)  
See: *Yaw angle*

**Angle of zero lift** (*propulsion, propulsor*) ( $\alpha_0$ ) [-]  
The angle of attack relative to the chord line for which the lift is zero.

**Apparent** (*seakeeping*)  
Referring to wave characteristics, a visible property of an irregular wave record as distinguished from a property of the component waves. Thus, an apparent wave height is a particular peak-to-trough distance.

**Apparent slip ratio** (*performance*)  
See: *Slip ratio, apparent.*

**Appendage** (*ship geometry*)  
An additional structure or fitting to the main underwater hull of a ship, which generally results in a discontinuity in the fair surface of the main hull. Examples of appendages are: rudders, bossings, struts, shafts, bilge keels, stabilizing fins, etc. (See appropriate items)

**Appendage scale effect factor** (*performance*) ( $\beta$ ) [-]  
A factor taking account of the effect of scale between model and ship on the resistance of appendages. It is defined by a factor  $\beta$ , where:

$$\frac{R_{APS}}{1/2 \rho_S V_S^2 S_S} = \beta \frac{R_{APM}}{1/2 \rho_M V_M^2 S_M}$$

Where  $R_{AP}$  is the appendage resistance (See: *Resistance, appendages*),  $\rho$  the fluid density,  $V$  the speed and  $S$  the wetted surface.

**Approach run** (*performance*)  
See: *Run, approach.*

**Approach speed** (*manoeuvring*)  
See: *Speed, approach*

**Area, above-water projected** (*performance*)

The area of the above-water hull, superstructure, deck erections, funnels, masts, and like, as projected onto either the vertical  $x$ - $z$  or  $y$ - $z$  plane of the ship. (See: *General Section* under *Axes, co-ordinate*).

**Area, bulbous bow in longitudinal plane** (*ship geometry*) ( $A_{BL}$ ) [ $L^2$ ]

The area of the ram projected onto the centreplane forward of the fore perpendicular.

**Area, control surface** (*manoeuvring*)

See: *Control surface area*.

**Area, developed** (*propulsion, propulsor*) ( $A_D$ ) [ $L^2$ ]

An approximation to the surface area of the propeller equal to the area enclosed by an outline of a blade times the number blades. The outline of a blade is constructed by laying off, at each radius  $r$ , the chord length along an arc whose radius of curvature,  $r_1$ , is equal to the radius of curvature of the pitch helix given by  $r_1 = r / \cos^2 j$  where  $\varphi$  is the pitch angle at that radius. The outline is formed by the locus of the end points of the chord lines laid out in the above manner.

**Area, disc** (*propulsion, propulsor*) ( $A_O$ ) [ $L^2$ ]

The area of the circle swept out by the tips of the blades of a propeller of diameter  $D$ :

$$A_O = \pi D^2 / 4$$

**Area, expanded** (*propulsion, propulsor*) ( $A_E$ ) [ $L^2$ ]

An approximation to the surface area of the propeller equal to the area enclosed by an outline of a blade times the number of blades. The outline of a blade is constructed by laying off at each radius  $r$ , the chord length along a straight line. The outline is formed by the locus of the end points of the chord lines laid out in the above manner.

**Area, lateral of the hull** (*manoeuvring*) ( $A_{HL}$ , formerly  $A_L$ ) [ $L^2$ ]

The area of the profile of the underwater hull of a ship when projected normally upon the vertical, longitudinal centreline, including the area of skegs, deadwood, ect. Usually areas which lie abreast of one another, such as those of multiple skegs, are included once only. Lateral area can refer not only to the whole body, but also to forebody, afterbody, entrance, run, ect. Thus  $A_{HLF}$ ,  $A_{HLA}$ ,  $A_{HLE}$ ,  $A_{HLR}$ , ect.

**Area, maximum section** (*ship geometry*) ( $A_X$ ) [ $L^2$ ]

See: *Section*

**Area, midship section, or midlength section** (*ship geometry*) ( $A_M$ ) [ $L^2$ ]

See: *Section*

**Area, planing bottom** (*ship geometry*) ( $A_{PB}$ ) [ $L^2$ ]

Horizontally projected planing bottom area (at rest), excluding area of external spray strips (See Figure 2-1 and Figure 2-2)

**Figure 2-1: Beam definitions for a hard chine hull**

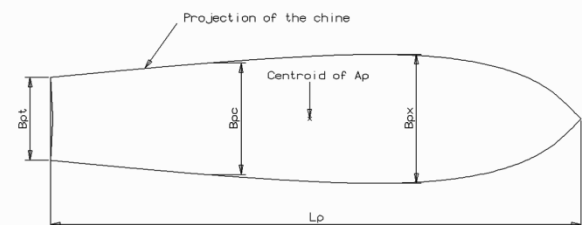

**Figure 2-2: Planing bottom area**

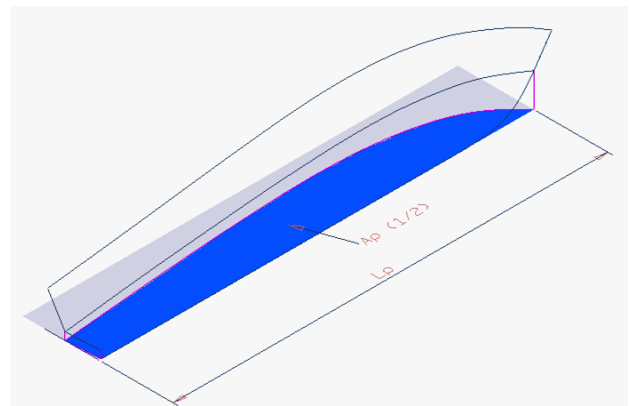

**Area, projected** (*propulsion, propulsor*) ( $A_P$ ) [ $L^2$ ]

The area enclosed by the outline of the propeller blades outside the hub projected on to a plane normal to the shaft axis. The outline is constructed by laying off, along each radius  $r$ , the extremities of each section as determined in a view along the shaft axis. The locus of the end points of the chord lines laid out in the above manner is the required outline.

**Area, transverse cross section of a bulbous bow** (*ship geometry*) ( $A_{BT}$ ) [ $L^2$ ]

The cross sectional area (full section port and starboard). Where the water lines are rounded so as to terminate on the fore perpendicular  $A_{BT}$  is measured by continuing the area curve forward to the perpendicular, ignoring the final rounding.

**Area, wind exposed** (*ship geometry*) ( $A_V$ ) [ $L^2$ ]

Area of the portion of ship above the waterline projected to the direction of relative wind.

**Aspect ratio** (*ship geometry, manoeuvring*)

See: *Ratio, aspect*.

**Attached cavities**(*cavitation*)

Term applied to cavitation region with fairly well defined line of attachment to the body about which it is formed. It may be a *Fully developed cavity* or *Partial cavity* (which see).

**Augment fraction, resistance** (*performance*)

See: *Resistance augment fraction*.

**Auto correlation** (*seakeeping*)

The correlation between a random function of time, or space, and the same function shifted in time, or space, by a specified "lag"  $\tau$ . The normalised auto correlation function is the auto covariance divided by the variance.

**Axes co-ordinates** (*general*)

Generally a system of rectangular Cartesian co-ordinates and in particular:

**Body axes** ( $x, y, z$ ) A right hand orthogonal system fixed in the body or ship. The  $x$  axis is forward and parallel to the reference or baseline used to define the body's shape. For dynamic considerations the origin should be at the centre of the gravity of the body and the  $z$  axis vertically downwards. The  $y$  axis is to starboard.

**Fixed axes** ( $x_0, y_0, z_0$ ). A right hand orthogonal system nominally fixed in relation to the earth; the positive  $z_0$  axis is vertically downwards and the  $x_0$  axis lies in the direction of initial motion.

**Axial induced velocity** (*propulsion, propulsor*)

See: *Induced velocity, axial*.



# B

**Back (of blade)** (*propulsion, propulsor*)

The side of a propeller blade which faces generally in the direction of ahead motion. This side of the blade is also known as the suction side of the blade because the average pressure there is lower than the pressure on the face of the blade during normal ahead operation. This side of the blade corresponds to the upper surface of an airfoil or wing.

**Back cavitation**(*cavitation*)

Cavitation occurring on the suction side (back) of a propeller blade.

**Baseline** (*ship geometry*)

The intersection of the baseplane with the plane of symmetry of the hull.

**Baseplane** (*ship geometry*)

See: *Planes, principal co-ordinate*

**Base-vented flow or bodies**(*cavitation*)

Flow in which the body has a fully ventilated, blunt trailing edge while the body itself is fully wetted.

**Beam** (*ship geometry*)  $B$  [L]

A dimension expressing breadth or width of a body or ship in a transverse horizontal direction. When not otherwise defined the beam is the breadth moulded of a ship, measured amidships at the design waterline. According to the position where the breadth is measured, it is named:

**Beam, extreme:** maximum beam wherever it occurs on the hull above or below water.

**Beam, immersed:** maximum: maximum beam of underwater body

**Beam, maximum section** ( $B_X$ ): beam measured on the designed waterline at the maximum section area.

**Beam, midlength** ( $B_M$ ): beam at the midsection of the designed waterline.

**Beam of design water line** ( $B_{WL}$ ) [L]: maximum moulded breadth at design water line

For a hard chine hull the beam refers to the breadth or width of the planing bottom. According to the position where the breadth is measured, it is named:

**Beam, over chines** ( $B_{PC}$ ) [L]: beam over chines, excluding external spray strips (See Figure 2-1).

**Beam, mean over chines** ( $B_{PA}$ ) [L]: mean breadth over chines; defined as the ratio between planing bottom area and projected chine length (See Figure 2-1).

$$B_{PA} = \frac{A_{PB}}{L_{PR}}$$

**Beam, transom** ( $B_{PT}$ ) [L]: Breadth over chines at transom, excluding external spray strips (See Figure 2-1).

**Beam, maximum over chines** ( $B_{PX}$ ) [L]: Maximum breadth over chines, excluding external spray strips (See Figure 2-1).

**Bilge** (*ship geometry*)

The submerged transversally curved portion of the ship between the side and bottom. This region is also called the turn of the bilge. The minimum radius of the bilge at the section of maximum area is called bilge radius.

**Bilge keel** (*ship geometry, seakeeping*)

See: *Keel*

**Blade area ratio** (*propulsion, propulsor*) [-]

A term used to denote the ratio of either the developed or expanded area of the blades to the disc area. The terms expanded area ratio or developed area ratio are recommended in order to avoid ambiguity.

**Blade section** (*propulsion, propulsor*)

Most commonly taken to mean the shape of a propeller blade at any radius, when cut by a circular cylinder whose axis coincides with the shaft axis.

**Blade section reference point** (*propulsion, propulsor*)

See: *Reference point, blade section*

**Blade thickness fraction** (*propulsion, propulsor*) [-]

If the maximum thickness of the propeller blade varies linearly with radius, then this variation of thickness may be imagined to extend to the axis of rotation. The hypothetical thickness at the axis of rotation,  $t_0$ , divided by the diameter, is known as the blade thickness fraction or blade thickness ratio. If the thickness does not vary linearly with radius, then the blade thickness fraction is not uniquely defined.

**Blockage** (*hydrodynamics*)

The effects of the boundaries of channel or tunnel on the flow around a body

**Blockage correction** (*hydrodynamics*)

A correction made to the results of a hydrodynamic experiments made in a channel or tunnel of one cross-section in order to estimate the equivalent results for another cross-section. Specifically a correction made to the results of a resistance experiment in a towing tank in order to estimate the equivalent results in unrestricted water.

**Block coefficient** (*ship geometry*) ( $C_B$ , formerly  $\delta$ ) [-]

The ratio of displacement volume  $\nabla$  to the volume of a rectangular block having length  $L$ , beam equal to the waterline beam  $B_X$  and draught  $T_X$ :

$$C_B = \frac{\nabla}{LB_X T_X}$$

If it is referred to length, beam or draught other than those defined above, they should be clearly defined.

**Body** (*ship geometry*)

Any hull or form which may be immersed or floating in a fluid, if a ship, usually its underwater portion. Particular parts of the body of a ship are:

**Forebody:** the part forward of the midsection

**Afterbody:** the part aft of the midsection

**Parallel middle-body, length of, ( $L_P$ )** the midship portion having the same transverse section throughout.

**Entrance, length of, ( $L_E$ ):** the portion extending from the maximum area section, or from the fore end of the parallel middle-body, to the forward extremity of the underwater body.

**Run, length of, ( $L_R$ ):** that portion extending from the maximum area section, or from the after end of the parallel middle-body, to the after extremity of the underwater body.

See Figure 2-16 for illustrations of these items.

**Body plan** (*ship geometry*)

The transverse sections of the ship projected on to a vertical transverse plane. The sections are generally equally spaced.

**Bollard pull** (*propulsion, propulsor*) [ $MTL^{-2}$ ]

The pull force exerted by a ship at zero ship speed. It is the sum of the propeller thrust and the interaction force on the hull.

**Boss** (*propulsion, propulsor*)

See: *Hub*.

**Bossing** (*ship geometry*)

The part of the underwater hull of a ship which is carried outward beyond the fair form to enclose the propeller shafts or other external items. Bossing are of two general forms:

- i. Short, intended only to house the aftermost hull bearing of a propeller shaft or to

form a faring where the propeller shaft emerges from the hull

- ii. Long, enclosing the entire propeller shaft, shaft bearings, and the supporting frame from the hull to the propeller.

A long bossing is called contra or deflection type when its end is shaped to direct the flow of water against the direction of rotation of propeller (See Figure 2-3).

Figure 2-3: Propeller shaft bossings

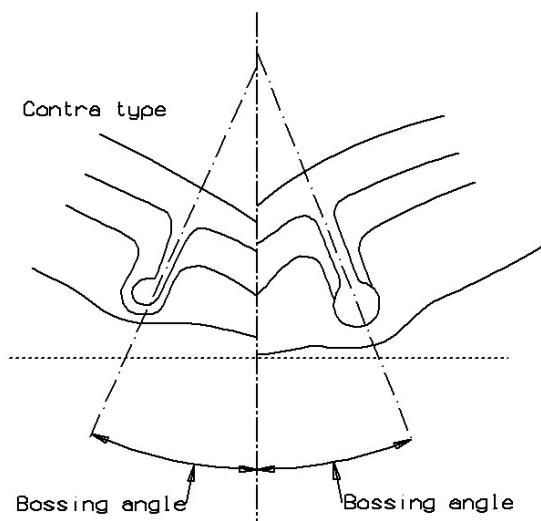

**Bossing, angle** (*ship geometry*)

Angle of bossing with the plane of symmetry (See Figure 2-3).

**Boundary layer** (*hydrodynamics*)

The region of fluid close to a solid body where, due to viscosity, transverse gradient of velocity are large as compared with longitudinal variations, and shear stress is significant. The boundary layer may be laminar, turbulent, or transitional. See also *Flow, regime*.

**Boundary layer thickness** (*hydrodynamics*) ( $\delta$ ,  $\delta^*$  or  $\delta_1$ ,  $\theta$ ,  $\theta^*$  or  $\delta^{**}$ ) [L]

**Boundary layer thickness** ( $\delta_{95}$ ): The distance normal to the surface of a body at which the speed attains that in an equivalent inviscid flow. For practical purposes this is

sometimes taken as 99.5% of the inviscid flow speed or 99.5% of the total head .

**Displacement thickness** ( $\delta^*$ ,  $\delta_1$ ): the distance normal to the surface of a body by which streamlines outside the boundary layer are displaced. For two-dimensional flow:

$$\delta^* = \int_{y=0}^{\delta} \left(1 - \frac{\bar{U}}{U_{\delta}}\right) dy$$

Where  $U_{\delta}$  = the velocity at the edge of the boundary layer and  $\bar{U}$  = velocity in the boundary layer.

**Momentum thickness** (*hydrodynamics*) ( $\theta$ ): A parameter such that the quantity  $\rho U_0^2 \theta$  is the defect in the rate transport of momentum due to the boundary layer. For two dimensional flow:

$$\theta = \int_{y=0}^{\delta} \frac{\bar{U}}{U_{\delta}} \left(1 - \frac{\bar{U}}{U_{\delta}}\right) dy$$

**Energy thickness** (*hydrodynamics*) ( $\theta^*$ ,  $\delta^{**}$ ): A parameter such that quantity  $\frac{1}{2} \rho U_0^3 \theta$   $\frac{1}{2} r U_0^3 q^*$  is the defect in the rate of transport of kinetic energy due to the boundary layer. This is given by:

$$\theta^* = \int_{y=0}^{\delta} \frac{\bar{U}}{U_{\delta}} \left(1 - \frac{\bar{U}^2}{U_{\delta}^2}\right) dy$$

**Boundary plate** (*ship geometry*)

A plate at, or near, the tip of a hydrofoil, or of an element acting as a hydrofoil, to suppress or reduce the tip vortex.

**Bow** (*ship geometry*)

The forward end of a ship

**Bowline** (*ship geometry*)

Intersection of a plane parallel to the centre plane with the moulded form of the forebody of the ship, both above and below the waterline. Similar intersections in the afterbody are called buttocks.

**Brake power** (*performance*)

See: *Power, brake*.

**Breadth** (*ship geometry*)

A length dimension expressing beam or width. (See: *beam*)

**Breadth coefficient of, R.E: Froude** (*ship geometry*) ( $B_C$ ) [-]

The ratio of the maximum breadth to the cube root of the volume displacement of a ship.

$$B_C = \frac{B_X}{\nabla^{1/3}}$$

in a consistent system of units.

**Breakwater** (*ship geometry*)

A protection erected on the weather deck, generally forward, normally V-shape in planform, to prevent water shipped over the bow from running aft.

**Broaching** (*seakeeping*)

An involuntary and dangerous change of heading produced by a severe following sea.

**Bubble collapse**(*cavitation*)

The final phase in the life history of a transient cavitation bubble that enters an increasing pressure field collapses and, unless containing considerable foreign gas, disappears. The total life of a transient cavitation bubble is measured in times of the order of milliseconds,

**Bubble growth**(*cavitation*)

The initial phase in the life history of a cavitation bubble in which a nucleus become unstable under a pressure reduction and grows explosively (*vaporous cavitation*) or which grows under quasi-equilibrium conditions by diffusion of gas (*gaseous cavitation*).

**Bubble rebound**(*cavitation*)

Regrowth, after initial collapse, of a transient cavity that contains considerable permanent gas, due to energy storage in the compressed gas. Several growth and rebound cycles have sometimes been observed.

**Bubble surface stability**(*cavitation*)

The stability of the bubble surface. Expanding bubbles are stable. Collapsing bubbles are un-

stable, being subject to Taylor instability (light fluid accelerated toward a heavier fluid) or distortions produced by body forces in a pressure gradient.

**Bulb** (*ship geometry*)

An appreciable swelling of the ship form generally below the waterline, involving increase of section area; frequently at the forward end lying just above the keel (bulbous bow), sometimes with increase of length beyond the forward perpendicular (ram bulb), sometimes the after end near the keel or at the level of the propeller shaft (stern bulb). The ram bulb dimensions are characterised by the transverse cross section area at the fore perpendicular ( $A_{BT}$ ), and the ram area in the longitudinal plane ( $A_{BL}$ ), which is the area of ram ahead of the fore perpendicular projected on to the centre plane. In non dimensional form:

**Taylor sectional area coefficient for bulbous bow** (*ship geometry*) ( $f_{BT}$ ) [-] :

$$f_{BT} = \frac{A_{BT}}{A_X}$$

**Area coefficient for ram bow** (*ship geometry*) ( $f_{BL}$ ) [-]:

$$f_{BL} = \frac{A_{BL}}{LT}$$

When the waterlines are rounded so as to terminate on the forward perpendicular,  $A_{BT}$  is measured by continuing the area curve forward to the perpendicular, ignoring the final rounding. In some instances, the stem contour recedes aft the fore perpendicular below the load waterline before projecting forward to define the outline of the ram or fore end of the bulb. In such instances this area should be calculated using as datum the aftermost vertical tangent to the contour instead of the fore perpendicular.

**Buttok** (*ship geometry*)

The intersection of a plane parallel to the centreplane with the moulded form of the ship, both below and above the waterplane. Specifically, all such intersections in the afterbody, as distinguished from similar intersections in the forebody, called bowlines.

# C

## Camber (*ship geometry*)

Generally applied to decks, where it represents the curvature in an athwartship or transverse vertical plane; the height of the deck at the centreline above the height at side. (See Figure 2-4).

Figure 2-4: Geometrical characteristics of midship section

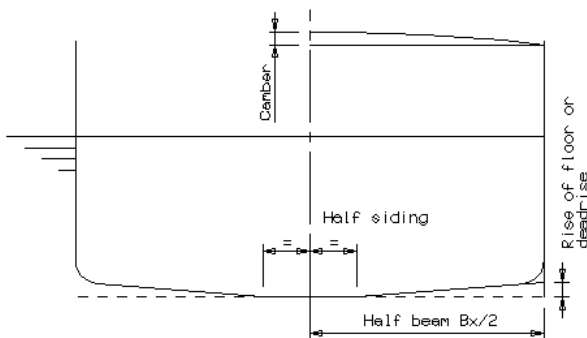

## Camber (of a foil section) (*ship geometry, propulsion, propulsor*) ( $f$ ) [L]

The maximum separation of the mean line and nose-tail line.

## Camber ratio (*propulsion, propulsor*) ( $\delta_f$ ) [-]

The camber divided by the chord length,  $f/c$

## Cap, propeller (*propulsion, propulsor*)

See: *Cone, propeller*

## Capillarity (*general*), ( $\sigma$ ) [ $M T^{-2}$ ]

Surface tension per unit length.

## Capillarity (phenomenon) (*general*),

A form of surface tension, by which a molecular force exist between the surface of a liquid and a solid. The surface of the liquid may thereby be elevated or depressed.

## Cavitating flow (*cavitation*)

A two-phase flow composed of a liquid and its vapour is called a *cavitating flow* when the phase transition is a result of a hydrodynamic pressure change.

## Cavitating wakes (*cavitation*)

Cavitation that occurs in the low pressure cores of the turbulent eddies which make up the wake of a moving body.

## Cavitation (*cavitation*)

In the most engineering contexts, cavitation is defined as the process of formation of the vapour phase of a liquid when it is subjected to reduced pressure at constant ambient temperature. In general, a liquid is said to cavitate when vapour bubbles are observed to form and grow as a consequence of pressure reduction. (See also: *Vaporous cavitation* and *Gaseous cavitation*).

## Cavitation damage (*cavitation*)

Deformation and/or erosion of materials in cavitated regions, associated primarily with the high pressures developed during cavity collapse.

## Cavitation inception (*cavitation*)

Inception of cavitation takes place when nuclei subjected to reduced pressure reach critical size and grow explosively. It is generally described

by the ambient pressure at which cavitation starts, or more precisely, by the *Critical cavitation number* (which see).

**Cavitation number (cavitation) ( $\sigma$ ) [-]**

The ratio of the difference between absolute ambient pressure  $p$  and cavity pressure  $p_C$  to the free stream dynamic pressure  $q$ :

$$\sigma = \frac{p - p_C}{q}$$

When the cavity pressure is assumed to be the vapour pressure  $p_V$  the term is generally called *Vapour cavitation number* (which see as *Cavitation number, vapour*).

**Cavitation number, critical (cavitation)**

Often used as an alternate to *Inception cavitation number* (which see as *Cavitation number, inception*).

**Cavitation number, inception ( $\sigma_1$ ) [-] (cavitation)**

The inception cavitation number  $\sigma_1$  is the value of the cavitation number  $\sigma$  at which the inception of cavitation occurs in a flowing system. When  $\sigma_1 > \sigma$ , cavitation will not occur; thus  $\sigma_1$  is the characteristic of the flow geometry while  $\sigma$  is characteristic of the liquid gas system. (In practical system, the definition of  $\sigma$  is usually based on the vapour pressure.) Sometimes also called *Critical cavitation number* (which see as *Cavitation number, critical*).

**Cavitation number, vapour ( $\sigma_V$ ) [-] (cavitation)**

The ratio of the difference between absolute ambient pressure  $p$  and vapour pressure  $p_V$  to the free stream dynamic pressure  $q$ :

$$\sigma_V = \frac{p - p_V}{q}$$

See also: *Cavitation number*.

**Cavity drag (cavitation) ( $D_C$ ) [LMT<sup>-2</sup>]**

The energy expended in forming a fully-developed cavity, which cannot be recovered at cavity closure and hence is exhibited as drag on

the body. It is equal to the energy in the re-entrant jet which is dissipated.

**Cavity length (cavitation) ( $l_C$ ) [L]**

The streamwise dimension of a fully developed cavitating region, extending from its leading edge (point of attachment) to the point of closure.

**Cavity pressure (cavitation) ( $p_C$ ) [L<sup>-1</sup>MT<sup>-2</sup>]**

Actual pressure within a steady (or quasi-steady) cavity. Approximately equal to the sum of the partial pressure of vapour and other gases diffused and entrained into the cavity.

**Cavity thickness (cavitation) ( $\delta_C$ ) [L]**

Maximum dimension of a fully developed cavity normal to the length dimension.

**Celerity (seakeeping)**

See: *Wave speed*.

**Centre of buoyancy (ship geometry) ( $B$ ) [-]**

The geometric centroid,  $B$  of the submerged volume of a body or ship through which the total buoyancy may be assumed to act. Its position, measured as the distance from midship or from the fore ( $\overline{FB}$ ) or after perpendicular ( $\overline{AB}$ ) is called the *Longitudinal centre of buoyancy* and from the base line or keel ( $\overline{KB}$ ) the *Vertical centre of buoyancy*. In non dimensional form these distances are often expressed as ratios of length of the ship  $\overline{FB}/L$  or  $\overline{AB}/L$ , and of the draught  $\overline{KB}/T$  respectively.

**Centre of flotation (ship geometry) ( $F$ ) [-]**

The geometric centroid of the area of water-plane of any waterline. Its position measured as the distance from midships or from the fore or after perpendicular, is called *Longitudinal centre of flotation*, and is generally expressed as a ratio of the waterline length.

**Centre of gravity (ship geometry) ( $G$ ) [-]**

The centre through which all the weights constituting the ship and its contents may be assumed to act. The distance measured from mid-

ships, from the fore perpendicular ( $\overline{FG}$ ) or from the after perpendicular ( $\overline{AG}$ ), and from the baseline or keel ( $\overline{KG}$ ) are called *Longitudinal and Vertical centre of gravity* respectively. They are generally expressed as ratios of the ship length  $\overline{FG}/L$  or  $\overline{AG}/L$  and of the ship depth  $\overline{KG}/D$  respectively.

**Centre of lateral area** (*manoeuvring*)

The centre of the lateral area of the immersed portion of a ship or body, taken generally in the plane of symmetry.

**Centre of lateral force** (*manoeuvring*)

The point in the plane of symmetry through which the resultant force would act to produce an effect equal to that of the total lateral hydrodynamic force on a vessel.

**Centreplane** (*ship geometry*)

See: *Planes, principal, co-ordinate.*

**Centrifugal spindle torque** (*propulsion, propulsor*)

See: *Spindle torque, centrifugal*

**Chemo-luminescence** (*cavitation*)

Visible light produced in the gas vapour of cavities in an ultrasonic field (see: *Sonoluminescence*) caused by chemical reactions associated with high pressure and/or temperatures.

**Chine** (*ship geometry*) (See Figure 2-5)

A more or less sharp corner or knuckle in the hull form, continuous over a significant length of the ship, as in the junction of side and bottom in planing craft. The chine is known as “soft” when the corner is rounded, and “hard” otherwise.

**Chine angle** (*ship geometry*) (See Figure 2-5)

The angle at the junction between the two parts of a section, on either side of a chine or the angle between the tangents to these two parts, measured in a transverse plane.

**Chine line** (*ship geometry*) (See Figure 2-5)

The actual (in a “hard” chine), or imaginary (in a “soft” chine), locus of the intersections of the two parts of the hull form at the chine.

Figure 2-5: Hull form with chine

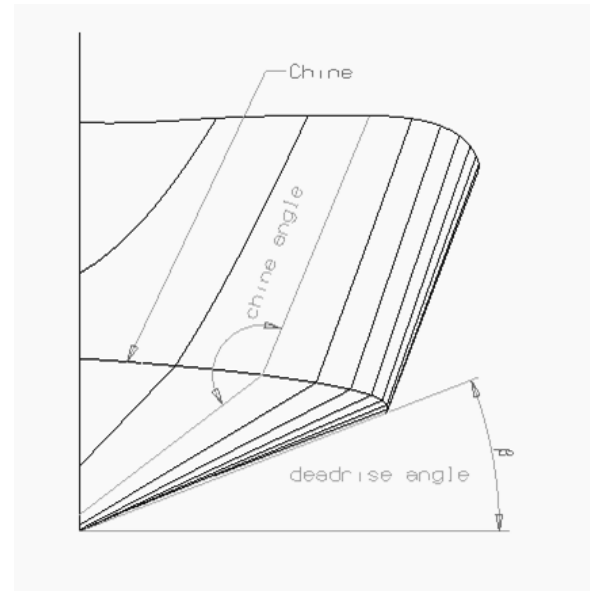

**Choked flow** (*cavitation*)

This is defined as the flow condition in which the drag of a body is directly proportional to the square of the upstream velocity and is not a function of the cavitation number. The pressure coefficient at any point on the body is independent of the cavitation number.

**Choking cavitation number** (*cavitation*)

This is defined as that value of  $\sigma$  at which a terminal, minimum value of the drag coefficient is found for a cavitating body.

**Chord (of a foil section)** (*ship geometry, propulsion, propulsor*) ( $c$ ) [L]

The length of the chord line which is the straight line connecting the extremities of the mean line of a hydrofoil section. It passes through, or nearly through, the fore and aft extremities of the section. Synonymous with nose-tail line.

**Chord length, mean** (*propulsion, propulsor*)  
( $c_M$ ) [L]

The quotient obtained by dividing the expanded or developed area of a propeller blade by the span from the hub to the tip.

**Chord line** (*propulsion, propulsor*)

The straight line connecting the extremities of the mean line. The length of this line is called the chord length or simply the chord. It passes through, or nearly through, the fore and aft extremities of the section. Synonymous with nose-tail line.

Figure 2-6: Propeller clearances

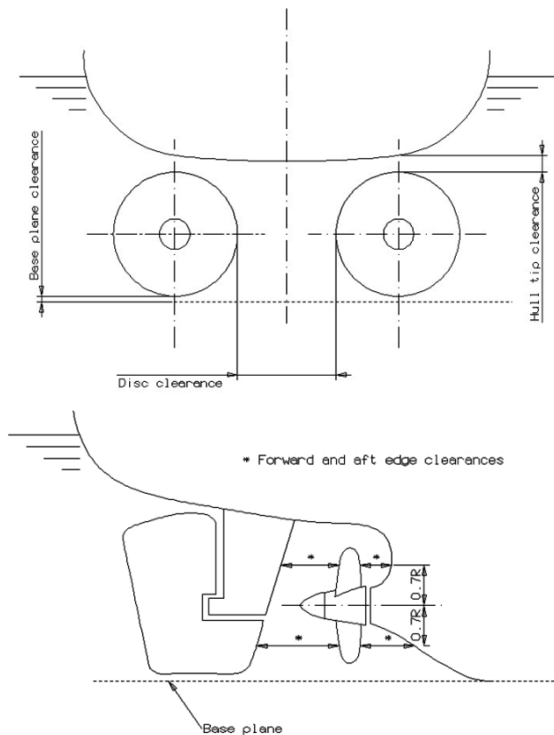

**Clearances, propeller** (*ship geometry*) (See Figure 2-6)

The clearances as indicated between the sweep line of a propeller and the hull or aperture in which is placed. As shown, the fore and aft clearances are generally measured at 0.70 of the propeller radius above and below the shaft centreline.

**Coefficient, Admiralty** (*performance*)

See: *Admiralty coefficient*.

**Coefficient, block** (*ship geometry*)

See: *Block coefficient*.

**Coefficient of lateral area** (*manoeuvring*)  
( $C_{AL}$ , formerly  $C_{LA}$ ) [-]

The ratio of the lateral area of the bare hull of a ship to the area of a rectangle having the ship length  $L$  and a constant depth equal to draft  $T_X$  at the station of maximum area.

**Coefficient, prismatic** (*ship geometry*)

See: *Prismatic coefficient*.

**Coefficient, prismatic, vertical** (*ship geometry*)

See: *Prismatic coefficient, vertical*.

**Coefficient, quasi-propulsive** (*performance*)

See: *Efficiency, propulsive*, and *Efficiency, quasi-propulsive*.

**Coefficient, maximum transverse and mid-ship section** (*ship geometry*)

See: *Sectional area coefficient*.

**Coefficient, waterplane, designed load** (*ship geometry*)

See: *Waterplane coefficient, designed load*.

**Coefficient, waterplane, inertia** (*ship geometry*)

See: *Waterplane inertia coefficient*.

**Coefficient, wind resistance** (*performance*)

See: *Resistance coefficient, wind*.

**Coherency** (*seakeeping*)

A measure of the linear dependency of two random functions of time, or space, analogous to a correlation coefficient.

**Collapse pressure** (*cavitation*) ( $p_{AC}$ ) [ $L^{-1}MT^{-2}$ ]

The pressure produced in the field of a collapsing cavitation bubble estimated to be of the order of thousands of atmospheres at the minimum radius reached before the process stops or rebound begins.



**Compressibility, coefficient of** (*general*), ( - )  
[ $\text{LM}^{-1} \text{T}^2$ ]

The reciprocal of the volume or bulk modulus of elasticity. (See: *Modulus of elasticity, volume or bulk*)

**Cone, propeller** (*propulsion, propulsor*)

The conical-shaped cover placed over the after end of the propeller shaft for the purpose of protecting the nut and forming a hydrodynamic fairing for the hub. Also known as a propeller fairwater or a propeller cap.

**Contrarotating propeller** (*propulsion, propulsor*)

See: *Propeller Types*.

**Control** (*general*),

As a noun, is applied to the act of controlling or directing, such as when controlling the movements of body or directing a ship in the steering, turning, and diving manoeuvres.

**Control devices** (*manoeuvring*)

Control devices comprise all the various devices that are used to control a body or ship, such as control surfaces, thruster, jets, ect.

**Control surfaces** (*general, manoeuvring*)

Control surfaces are the rudders, hydroplanes and other hinged or movable devices used for controlling the motion of a body or ship.

**Control surface area** (*manoeuvring*) (  $A_{FB}$ ,  $A_{FS}$ ,  $A_R$ , ect) [ $\text{L}^2$ ]

The plan form area of any active or movable control surface, such as that of bow fins  $A_{FB}$ , stern fins  $A_{FS}$  or rudder  $A_R$ , measured on the reference plane (generally the plane of symmetry). See also: *Rudder area*.

**Control surface angle** (*manoeuvring*) ( $\delta_{FB}$ ,  $\delta_R$  ect) [-]

The angular displacement of any control surface about its hinge or stock, such as that of a bow fin  $\delta_{FB}$ , or rudder  $\delta_R$ . Positive when turning in the positive sense of rotation of the ship, regardless of the effect this angle may have on the ship. See also: *Rudder angle*.

**Controllability** (*general*)

That quality of a body or ship which determines the effectiveness of movement of the controls in the producing any desire change, at a specified rate in the attitude or position of the moving body or ship

**Controls** (*general*)

The means or system provided to enable the crew of a ship to control its speed, power, attitude, direction of motion, and the like.

**Correlation allowance, model-ship** (*performance*) ( $R_A$ ) [ $\text{LMT}^{-2}$ ]

This is the addition which has to be made to the resistance of the “smooth” ship, as predicted from the model results, to bring it into agreement with the actual ship performance determined from full scale trial or service result. The correlation allowance depends upon the method used to extrapolate the model results to the “smooth” ship, the ship length and type, the basic shell roughness of the newly-painted ship, fouling, weather conditions at the time the ship measurements were taken and scale effects on the factor making up the model and ship propulsive coefficients.

**Correlation allowance coefficient** (*performance*)

See: *Resistance coefficient, incremental, for model-ship correlation*.

**Correlation factor, ship-model, for propeller rate of evolution** (*performance*) ( $K_2$ ) [-]

The scale effect between the rate of propeller rotation of model  $n_M$  and ship  $n_S$  is defined by the factor  $K_2$ , such that

$$K_2 = \frac{n_S}{n_M} \sqrt{\lambda}$$

where  $\lambda$  is the scale factor.

**Correlation factor, ship-model, for propulsive or quasi-propulsive efficiency** (*performance*) ( $K_1$ ) [-]

The scale effect between the propulsive efficiencies of the model and ship is defined by the factor  $K_1$ , such that

$$K_1 = \frac{\eta_{DS}}{\eta_{DM}}$$

where the efficiencies  $\eta_{DS}$  and  $\eta_{DM}$  for ship and model respectively are derived at corresponding speed and propeller loading.

**Counter** (*ship geometry*)

The overhanging portion of stern of a ship which lies between the designed waterplane and deck and which project abaft the waterline termination. See also *Stern, Counter* or *Fantail* and Figure 2-19 a).

**Coupling** (*seakeeping*)

Influence of one mode of motion on another mode of motion, for instance, coupling between heave and pitch.

**Course made good** (*performance, manoeuvring*)

The mean direction which a ship moving. This is defined by degrees of the compass or degrees of azimuth in a horizontal plane. (See Figure 7-4).

Figure 7-4: Course characteristics

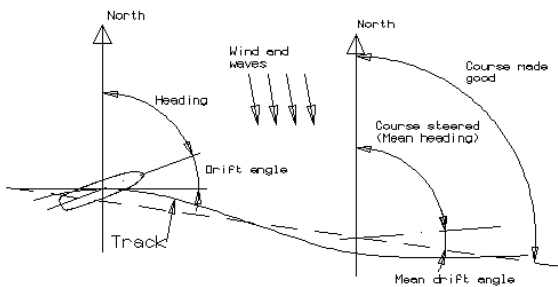

**Course measured** (*performance*)

A straight measured course, which is used for speed trials of a ship. When such a course is one nautical mile in length it is often referred to as a measured mile.

**Course, original** (*performance*) ( $\psi_0$ ) [-]

The course at the beginning of a manoeuvring test, defined by degrees of the compass or de-

gree of azimuth in a horizontal plane (See Figure 7-1 and Figure 7-2).

**Course steered** (*performance*) ( ) [-]

The mean heading of a ship, defined by degrees of the compass or degrees of azimuth in a horizontal plane. (See Figure 7-4).

(*manoeuvring*) ( $\psi_0$ ) [-]

The mean heading of a ship, defined by degrees of the compass or degree of azimuth in a horizontal plane (See Figure 7-4).

**Covariance** (*seakeeping*)

Average of squares of the deviations from the mean value.

**Crash-back , Crash Stop** (*manoeuvring*)

A ship manoeuvre in which, while going ahead at normal or some other speed, the propulsion devices are reversed in the shortest possible time.

**Critical cavitation number** (*cavitation*)

See: *Cavitation number critical*.

**Critical pressure** (*cavitation*) ( $p_{AI}$ ) [ $L^{-1}MT^{-2}$ ]

The absolute pressure at which cavitation inception takes place, in either a flowing system or an imposed pressure field (as in ultrasonic cavitation). In turbulent flow, the critical pressure will be a function of the average hydrodynamic pressure and the pressure fluctuations associated with turbulence. Sometimes also called *Inception pressure*. (See also: *Gaseous* and *Vaporous cavitation*.)

**Critical velocity** (*cavitation*) ( $U_i$ ) [ $LT^{-1}$ ]

In a flowing system (or its equivalent: a body moving through a liquid), the free stream velocity at which cavitation inception takes place in a field of constant ambient pressure. In a turbulent flow, the critical velocity is also dependent on the velocity fluctuations associated with turbulence. Sometimes also called *Inception velocity*.

**Cross-correlation** (*seakeeping*)

The correlation between two random functions of time, or pace, with one shifted in relation to the other by a “lag”  $\tau$ .

**Cross force** (*manoeuvring*) ( $C$ )

See: *Force, cross*

**Cross force coefficient** (*manoeuvring*) ( $C_c$ ) [-]

The ratio of the cross force  $C$  on a ship or body to the force corresponding to the dynamic pressure times a specified area. It is customary to express it as  $C_c = C/qA$ .

**Current, tidal** (*performance*)

A current in the water caused by the tide and influenced by the coastline and contours of the seabed.

**Current, wind** (*performance*)

A surface or near-surface current in a body of water induced by wind.

**Cutaway** (*ship geometry*) (See Figure 2-7)

A volume cut out of a body, specifically at the forward or after end of a ship.

Figure 2-7: Cutaway at fore end of ship

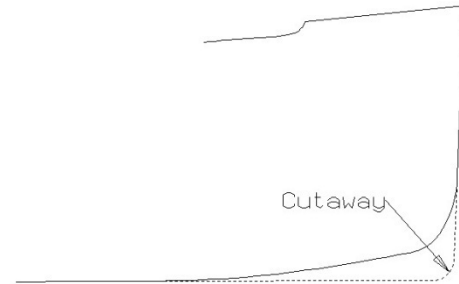

**Cutwater** (*ship geometry*)

A narrow sharp portion of the stem of a ship at the waterline, or an appendage added to the stem to reduce the spray.

**Cycloidal propeller** (*propulsion, propulsor*)

See: *Propeller Types*.

# D

**Damping** (*seakeeping*)

A characteristic property of a dynamic system, which dissipates energy and reduces the motion.

**Damping coefficient** (*seakeeping*)

Ratio of damping force or moment amplitude as a function of frequency.

**Deadrise angle** (*ship geometry*) ( $\beta$ ) [rad]

Angle between a straight line approximating the bottom part of a body section and the intersection between basis plane and section plane (See Figure 2-5).

According to the position where the deadrise angle is measured, it is named:

**Deadrise, angle at midship** ( $\beta_M$ ) [rad]: deadrise angle at midship section

**Deadrise, angle at transom** ( $\beta_T$ ) [rad]: deadrise angle at transom

See also: *Floor, rise of - or deadrise*

**Deadwood** (*ship geometry, manoeuvring*) (See Figure 2-8)

See: *Skeg*.

Figure 2-8: Deadrwood at aft end of ship

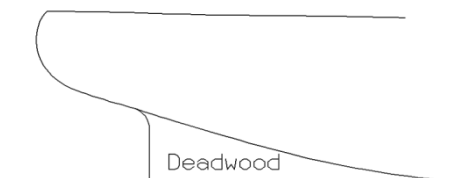

**Deceleration zone** (*cavitation*)

In the sequence of cavitation erosion, the zone of the curve of weight loss versus time in which the rate of weight loss decrease (the region fol-

lowing the *acceleration zone*, which see). Formerly called the *Attenuation zone*.

**Delivered power** (*performance*)

See: *Power, delivered*.

**Density, mass** (*general*), ( $\rho$ ) [ $L^{-3} M$ ]

The mass per unit volume of a substance. \*

**Density, weight** (*general*), ( $w$ ) [ $L^{-2} M T^{-2}$ ]

The weight per unit volume of a substance.

**Depth, moulded of a ship hull** (*ship geometry*) ( $D$ ) [L]

The moulded depth of a ship, defined as the height above the baseplane of the lowest point of a deck where it joins the side of ship.

**Derivatives, stability and control** (*manoeuvring*)

The hydrodynamic forces and moments which enter into the equations of motion are usually classified into three categories: static, rotary, and acceleration. The static derivatives are due to the components of linear velocity of the body relative to the fluid. Rotary derivatives are derived from angular velocity of the body and acceleration derivatives are from either linear or angular acceleration of the body.

**Desinent cavitation** (*cavitation*)

Cavitation under conditions of pressure and velocity such that cavitation will be suppressed by a slight change in the ambient conditions: pressure increase and /or velocity reduction.

**Developed area** (*propulsion, propulsor*)

See: *Area, developed*.

**Developed area ratio** (*propulsion, propulsor*) ( $a_D$ ) [-]

The ratio of the developed area of the propeller blades to the disc area.

**Diagonal** (*ship geometry*)

The trace on the outside of a body marking the intersection of a plane passing through it at an angle other than 90° to the baseplane. Specifically for a ship of normal form, the diagonal plane is generally parallel to the baseline.

**Diameter, steady-turning** (*manoeuvring*)

The diameter of the circular arc described by the centre of gravity of a ship when it has achieved a steady-turning state.

**Diameter, tactical** (*manoeuvring*) (See Figure 7-1)

The distance travelled by the centre of gravity of the ship normal to its original approach path in turning through 180 degrees. Tactical diameter is equal to the transfer at 180 degrees change of heading.

**Dihedral, Angle** (*ship geometry*) (-) [-]

The complement of the acute angle between the plane of symmetry of a craft or body and the axis of a hydrofoil attached to it projected on to a transverse plane.

**Directional stability** (*manoeuvring*)

See: *Stability, directional*.

**Doublet** (*hydrodynamics*)

A source-sink pair where the axial spacing tends to zero as the product of axial spacing and the source strength remains constant. The value of that product is the “moment” of the doublet, and the direction from the sink to the source is the “axis” of the doublet. Consequently, a doublet of moment  $M$  (dimension  $L^4T^{-1}$ ) and of axis  $x$  located in a point A generates at any point P a velocity potential:

$$\phi = -\frac{M}{4\pi r^2} \frac{\partial r}{\partial x} = -\frac{M}{4\pi r^2} \cos\theta$$

Where  $r = AP$  and  $\theta =$  angle between AP and axis  $x$ <sup>(1)</sup>. If  $M < 0$ , the axis of the doublet would

be in the negative  $x$ -direction. In two dimensional problems, the definition holds. But the potential generated by a doublet of moment  $M$  (dimension  $L^3T^{-1}$ ) and of axis  $x$  is:

$$\phi = -\frac{M}{2\pi r} \frac{\partial r}{\partial x} = -\frac{M}{2\pi r} \cos\theta$$

where  $r = AP$  and  $\theta =$  angle between AP and axis  $x$ .

<sup>(1)</sup> See: *Potential function* or *Velocity potential*.

**Downwash or sidewash** (*manoeuvring*)

The deflection of a stream of fluid by any hydrofoil producing lift or thrust.

**Downwash or Induced angle** (*manoeuvring*)

( $\alpha_{IND}$ , formerly  $\epsilon$ ) [-]

The angle of downwash (which see) measured in a plane through the nose-tail line of the hydrofoil and perpendicular to the hydrofoil axis.

**Drag** (*ship geometry*) (-) [L]

A designed trim. (American usage – See: *Trim*) (*hydrodynamics*) ( $D$ ) [ $LMT^{-2}$ ]

The fluid force acting on a moving body in such a way as to oppose its motion; the component of the fluid forces parallel to the axis of motion of a body. Drag is the preferred term in aerodynamics and for submerged hydrodynamic bodies, while resistance is generally used in ship hydrodynamics. The various forms of drag are defined in relation to resistance. See also *Resistance*.

**Drag coefficient** (*hydrodynamics, manoeuvring*) ( $C_D$ ) [-]

A non-dimensional relationship between the drag  $D$  of a ship or body and the dynamic pressure times a specified area. It is customary to express it as  $C_D = D/qA$ .

**Draught** (*ship geometry*) ( $T$ ) [L]

The vertical distance, from the water surface to the bottom, of the underwater body of a ship. Specifically, the draught moulded, at midships to the design waterplane. When different, the draught at the transverse section having maximum area is indicated as  $T_X$

**Drift** (*seakeeping, manoeuvring*)

That motion, or component of motion, caused by some action other than that of the main propulsion devices of a ship, such as wind, waves, current and like. See also: *Sideslip*.

**Drift or sideslip, angle of** (*seakeeping*) ( $\beta$ ) [-]

The horizontal angle between the instantaneous direction of motion of the centre of gravity of a ship and its longitudinal axis. It is positive in the positive sense of rotation about the vertical body's axis.

**Ducted propeller** (*propulsion, propulsor*)

See: *Propeller Types*.

**Dynamic** (*general*),

As an adjective, pertains to motion as the result of force, or to bodies and system in motions; in this respect it is opposite of *static* (which see)

**Dynamic pressure** (*hydrodynamics*)

See *Pressure, dynamic*

**Dynamic stability** (*general, manoeuvring*),

That property of body which cause it, when slightly disturbed from a steady motion, to resume that the same steady motion, usually along a different path, without any corrective control being applied. See: *Stability dynamic*.

# E

## Edges, leading and trailing (*manoeuvring*)

The upstream and downstream edges, respectively, of a hydrofoil, propeller blade, rudder or similar device.

## Effective advance angle (*propulsion, propulsor*)

See: *Angle, effective advance.*

## Effective angle of attack (*propulsion, propulsor*)

See: *Angle of attack, effective.*

## Effective pitch (*propulsion, propulsor*)

See: *Pitch, effective.*

## Effective power (*performance*)

See: *Power, effective.*

## Effective wake fraction (*performance*)

See: *Wake fraction, effective.*

## Efficiency, gearing (*performance*) ( $\eta_G$ ) [-]

The ratio of the power output to the power input of a set of reduction – or multiplying – gears between an engine and propulsion device:

$$\eta_G = \frac{P_S}{P_B}$$

where  $P_S$  and  $P_B$  are the shaft and brake powers respectively (which see).

## Efficiency, hull (*performance*) ( $\eta_H$ ) [-]

The ratio between the useful work done on the ship and the work done by the propeller or other propulsion devices in a given time that is effective power  $P_E$  and thrust power  $P_T$  respectively.

$$\eta_H = \frac{P_E}{P_T} = \frac{R_T V}{TV_A} = \frac{1-t}{1-w} \quad \text{in Taylor notation}$$

or

$\eta_H = (1 + w_F)(1 - t)$  in Froude notation, where  $R_T$  is the total resistance,  $V$  the ship speed,  $T$  the propeller thrust and  $V_A$  the speed of advance;  $t$  is the thrust deduction fraction;  $w$  and  $w_F$  are the wake fractions according to Taylor and Froude respectively (which see).

## Efficiency, mechanical (*propulsion, propulsor*) ( $\eta_M$ ) [-]

The ratio between the power output and the power input of any machinery installation.

$$\eta_M = \frac{P_S}{P_I}$$

or

$$\eta_M = \frac{P_B}{P_I}$$

where  $P_S$  and  $P_B$  are the shaft and brake powers respectively and  $P_I$  is the indicated power (which see).

## Efficiency, propeller, behind hull (*performance, propulsion, propulsor*) ( $\eta_B$ ) [-]

The ratio between the power  $P_T$ , developed by the thrust of the propeller and the power  $P_D$  absorbed by the propeller when operating behind a model or ship:

$$\eta_B = \frac{P_T}{P_D} = \frac{TV_A}{2\pi Qn} = \eta_O \eta_R$$

where  $T$  is the thrust,  $V_A$  speed of advance,  $Q$  shaft torque and  $n$  rate of propeller rotation;  $\eta_O$  and  $\eta_R$  are the open water propeller and relative rotative efficiencies respectively.

## Efficiency propeller, open water (*propulsion, propulsor performance*) ( $\eta_O$ ) [-]

The ratio between the power developed by the thrust of the propeller  $P_T$ , and the power ab-

sorbed by the propeller  $P_D$  when operating in open water with uniform inflow velocity  $V_A$ :

$$\eta_0 = \frac{P_T}{P_D} = \frac{TV_A}{2\pi Q_0 n}$$

where  $T$  is the thrust,  $Q_0$  the torque in open water and  $n$  the rate of propeller rotation.

**Efficiency, propulsive (performance) ( $\eta_P$ ) [-]**

The ratio between the useful or effective power  $P_E$  and the brake power  $P_B$ .

$$\eta_P = \frac{P_E}{P_B} = \eta_0 \eta_H \eta_R \eta_S \eta_G$$

where  $\eta_0$ ,  $\eta_H$ ,  $\eta_R$ ,  $\eta_S$  and  $\eta_G$  are the open water propeller, hull relative rotative shafting and gearing efficiencies respectively (which see).

**Efficiency, quasi-propulsive or quasi-propulsive coefficient (propulsion, propulsor performance) ( $\eta_D$ ) [-]**

The ratio between the useful or effective power  $P_E$  and the power delivered to the propeller or the propulsion device  $P_D$ .

$$\eta_D = \frac{P_E}{P_D} = \eta_0 \eta_H \eta_R$$

where  $\eta_0$ ,  $\eta_H$  and  $\eta_R$  are the open water propeller, hull and relative rotative efficiencies respectively (which see).

**Efficiency, relative rotative (propulsion, propulsor, performance) ( $\eta_R$ ) [-]**

The relative rotative efficiency is the ratio of the propeller efficiencies behind the hull and in open water, as already defined.

$$\eta_R = \frac{\eta_B}{\eta_0}$$

**Efficiency, shafting (performance) ( $\eta_S$ ) [-]**

The shafting efficiency is a measured of the power lost in shaft bearings and stern tube:

$$\eta_S = \frac{P_D}{P_S}$$

where  $P_D$  and  $P_S$  are the delivered and shaft powers respectively (which see).

**Electrolytic effects (cavitation)**

Enhancement of cavitation erosion by electrochemical interactions due to local differences in the liquid or metal structure.

**Emergence (seakeeping) () [L]**

The relative vertical distance of a part (usually the bow) of an oscillating ship above the water surface; opposite to submergence.

**Emergence, tip (propulsion, propulsor) [L]**

The vertical distance from the top of the propeller tip circle to the at-rest water surface when the tips are exposed.

**Entrance (ship geometry)**

See: *Body*.

**Entrained gas content**

See: *Gas content*.

**Equilibrium (general),**

A state of balance, between opposing forces or actions.

**Equipotential line (hydrodynamics)**

A line in a potential flow field along which the velocity potential  $\phi$  is constant.

**Even Keel (ship geometry)**

This term is used to define the condition in which the ship has its keel parallel to the water surface. For vessels in which the keel is not straight or normally parallel to the water surface its use is not recommended: "zero trim" or "level trim" are preferred.

**Expanded area (propulsion, propulsor)**

See: *Area, expanded*.

**Expanded area ratio (propulsion, propulsor) ( $a_E$ ) [-]**

The ratio of the expanded area of the blades to the disc area.



# F

**Face (of blade)** (*propulsion, propulsor*)

The side of the propeller blade which face downstream during ahead motion. This side of the blade is also known as the pressure side because the average pressure on the face of the blade is higher than the average pressure on the back of the blade during normal operation. The face corresponds to the lower surface of an air-foil or wing.

**Face cavitation** (*cavitation*)

Cavitation occurring on the pressure side (face) of a propeller blade. It is generally a result of operation such that the local blade angle of attack is excessively negative.

**Face pitch** (*propulsion, propulsor*)

See: *Pitch, face*

**Factor, appendage scale effect** (*performance*)

See: *Appendage scale effect factor.*

**Factor, form** (*performance*)

See: *Form factor.*

**Factor, load** (*performance*)

See: *Power prediction factor.*

**Factor, magnification** (*seakeeping*)

The ratio of the output amplitude at a certain frequency to the static response.

**Factor, ship-model correlation** (*performance*)

See: *Correlation factor.*

**Factor, tuning** (*seakeeping*) ( $\Lambda$ ) [-]

Ratio of excitation frequency to natural frequency or ratio of natural period of a motion to period of encounter. The tuning factor in heave, pitch and roll have the symbol

$$\Lambda_z = \frac{\omega_E}{\omega_z} \quad \Lambda_\theta = \frac{\omega_E}{\omega_\theta} \quad \Lambda_\phi = \frac{\omega_E}{\omega_\phi}$$

or

$$\Lambda_z = \frac{T_z}{T_E} \quad \Lambda_\theta = \frac{T_\theta}{T_E} \quad \Lambda_\phi = \frac{T_\phi}{T_E}$$

respectively

**Fillet** (*propulsion, propulsor*)

The transition region (fairing) between the propeller hub and the blades at the blade root.

**Fin** (*ship geometry*)

A fixed or moveable hydrofoil, attached to a ship generally in a longitudinal direction, to improve the dynamic stability or manoeuvrability, or to provide a lift force to windward, as in the fin keel of a sailing yacht.

**Fin** (*manoeuvring*)

A fixed or movable hydrofoil, attached to a ship, generally in a longitudinal direction, to improve the dynamic stability or the manoeuvrability, or to provide a lift force to windward, as in the fin keel of a sailing yacht.

**Flap** (*ship geometry*) (See Figure 2-9)

A hinged, movable, auxiliary hydrofoil, forming the aftermost portion of a main hydrofoil.

Figure 2-9: Hydrofoil with flap

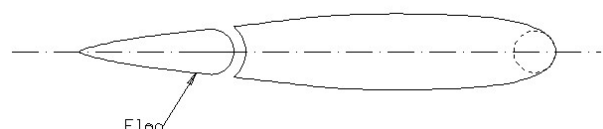

**Flare** (*ship geometry, seakeeping*) (See Figure 2-10)

The slant upward and outward from the vertical of a transverse section of a hull above the design waterline. Flare is opposite of tumble-home; its slope measured with respect to the horizontal, generally in the entrance and generally less than  $90^\circ$ , is called Angle of flare.

Figure 2-10: Transverse ship section with flare

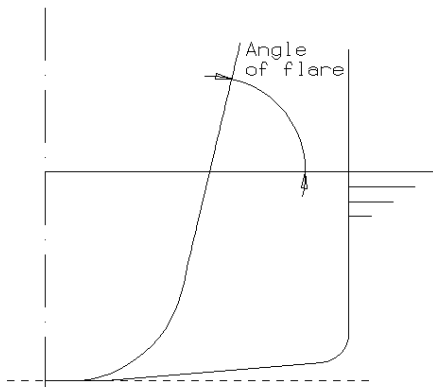

**Floor, rise of - or deadrise** (*ship geometry*) (-) [L] (See Figure 2-4)

The vertical distance above the baseline of the intersection point of the prolongation of the flat of the bottom at the maximum section area with a vertical straight line at half-beam from the centreplane.

**Flow, laminar** (*hydrodynamics*)

The flow of a viscous liquid in which layers of laminae of fluid appear to slide smoothly past each other. Momentum transfer and shear between neighbouring layers of fluid are due to molecular interactions only.

**Flow, potential** (*hydrodynamics*)

A flow field in which the fluid velocity  $\bar{U}$  is equal to the gradient of a scalar velocity potential  $\phi$ ,  $\bar{U} = \text{grad}\phi$ , i.e. in which no vorticity is present,  $\text{curl } \bar{U} = 0$ . See also *Potential function*.

**Flow, regime** (*hydrodynamics*)

A term referring to the state of the flow in any region; the principal recognised regimes are

laminar, transitional, turbulent and separated flows.

**Flow, reversed** (*hydrodynamics*)

Flow occurring in an eddy or separated zone in which the local flow has a component opposite in direction to that of the main flow.

**Flow, secondary** (*hydrodynamics*)

A transverse flow induced by the boundary layer geometry and by pressure conditions existing in the main flow.

**Flow, separated** (*hydrodynamics*)

The detachment of the main fluid flow from a solid surface due to an adverse longitudinal pressure gradient sometimes caused by a sudden change of the direction or the curvature of the surface. The fluid in the separated flow contains eddies, and may be nearly static or may contain a region of reversed flow.

**Flow, steady** (*hydrodynamics*)

Flow in which the velocity pattern is independent of time.

**Flow, transitional** (*hydrodynamics*)

An unstable state of viscous flow between the laminar and turbulent regimes.

**Flow, turbulent** (*hydrodynamics*)

A flow in which there are rapid and apparently random fluctuations both in the magnitude and in the direction of velocity. The velocity fluctuations may also be described by a random spectrum of vortices of varying size and strength. Turbulent resistance is higher than that in laminar flow at the same Reynolds number, because of the high momentum exchange by transverse fluctuations.

**Flow, uniform** (*hydrodynamics*)

Flow in which all velocity vectors are parallel and equal.

**Flow, viscous** (*hydrodynamics*)

The flow of a fluid where the flow characteristics include the effects of the shear forces acting on the fluid, and within it.

**Fluid, perfect or ideal** (*hydrodynamics*)

A hypothetical fluid which is homogeneous, inviscid and incompressible.

**Foam cavitation** (*cavitation*)

A cavitated region formed entirely of a mass of transient cavities so as to resemble foam (formerly called *burbling cavitation*).

**Force components, hydrodynamic** (*manoeuvring*) ( $X, Y, Z$ ) [ $\text{LMT}^{-2}$ ]

The components of the total hydrodynamic force on a body or ship as resolved along its  $x$ -,  $y$ - and  $z$ -axes respectively. Related to the flow over the body, the components are the drag component,  $D$  or  $R$ , in the direction of the relative flow; the lift component,  $L$ , in the principal plane of symmetry normal to the relative flow; the cross force,  $C$ , on the body normal to lift and drag.

**Force, cross** (*manoeuvring*) ( $C$ ) [ $\text{LMT}^{-2}$ ]

A force exerted on a body, a hydrofoil, or a ship, with or without an angle of attack, at right angles to both the direction of lift and the direction of drag.

Note: This is to be carefully distinguished from the lateral force; see: *Force, sway*.

**Force, damping** (*seakeeping*)

A force which tends to reduce the motion and, if assumed to be linear, is proportional to the velocity.

**Force exciting** (*seakeeping*)

A fluctuating external force that causes motion of body, as for instance, a ship when encountering a train of waves.

**Force, restoring** (*seakeeping*)

A force tending to return a body to its initial condition when displaced by an external force.

**Force, sway** (*manoeuvring*) ( $Y$ ) [ $\text{LMT}^{-2}$ ]

The component of the total hydrodynamic force exerted by liquid on a body, acting perpendicular to the plane of symmetry. Specifically, the force developed on a ship, acting normal to the plane of symmetry, when the ship is caused to

move sidewise in a horizontal plane, as in drifting, skidding or crabbing.

**Force, wave shearing, horizontal or lateral** (*seakeeping*) ( $F_L$ ) [ $\text{MLT}^{-2}$ ]

That part of the inertial lateral shearing force acting on a cross section of a hull that is caused by the action of waves and ship motions.

**Force, wave shearing, normal or vertical** ( $F_N$ ) [ $\text{MLT}^{-2}$ ]

That part of the inertial vertical shearing force acting on a cross section of a hull that is caused by the action of waves and ship motions.

**Forefoot** (*ship geometry*)

The part of the bow of a ship at or near the intersection of the stem with the keel.

**Form effect** (*performance*)

The difference between the viscous resistance of a model or a ship and the two dimensional friction resistance of a flat plate of the same length and wetted area and at the same speed in a given fluid. The difference arises because of the augmented speed of flow around the ship form as compared with along a flat plate and the pressure resistance of viscous origin. See also: *Form factor*.

**Form factor** (*performance*) ( $k$ ) [-]

The ratio between the total viscous resistance coefficient of a model or a ship  $C_V$  and the two dimensional frictional resistance coefficient of a flat plate  $C_{F0}$  at the same free stream Reynolds number. It may be expressed in two ways, either:

$$k = \frac{C_V - C_{F0}}{C_{F0}}$$

or

$$k = \frac{C_V - C_F}{C_F}$$

**Fraction overload** (*performance*)

See: *Power prediction factor*.

**Fraction, resistance augment** (*performance*)

See: *Resistance augment fraction*.

**Fraction, thrust deduction** (*performance*)

See: *Thrust deduction fraction*.

**Fraction, wake**

See: *Wake fraction*.

**Frame section** (*ship geometry*)

The intersection of the hull form with a vertical transverse plane, at the position of a transverse frame of the ship.

**Freeboard** (*ship geometry, seakeeping*) ( $f$ ) [-]

The vertical distance between the surfaces of the undisturbed water, in which a ship is floating, and the edge of a reference deck (Freeboard deck) or other reference point. In certain governmental load line rules, a minimum freeboard is specified at midship.

**Free gas content** (*cavitation*)

See: *Gas content*.

**Free streamline flow** (*cavitation*)

Fully developed cavity flow. For steady flows, the cavity walls are stream surfaces of the flow with the unique feature that the pressure is constant on the free streamlines. The term originates in the mathematical problem that the boundaries are “free” to be determined by the known condition of constant pressure.

**Frequency** (*seakeeping*) ( $f$ ) [ $T^{-1}$ ]

The number of cycles occurring per unit of time.

**Frequency, circular** (*seakeeping*) ( $\omega$ ) [ $T^{-1}$ ]

In any cyclic motion, or in any periodic motion which may be represented by a cyclic motion, the circular frequency is the angular velocity. If  $\omega$  is in radiant per second, then

$$\omega = \frac{2\pi}{T} \quad \text{and} \quad f = \frac{\omega}{2\pi}$$

where  $T$  is the period and  $f$  is the frequency.

**Frequency of wave** (*seakeeping*) ( $f_w$ ) [ $T^{-1}$ ]

The number per unit time of successive crests of a train of waves at a fixed angle of encounter,  $\mu$ , the reciprocal of the wave period  $T_w$ .

**Frequency of wave encounter** (*seakeeping*) ( $f_E$ ) [ $T^{-1}$ ]

The number per unit time of successive crests of a train of waves meeting a fixed point of a ship, at a fixed angle of encounter,  $\mu$ , the reciprocal of the period of encounter  $T_E$ . In deep water:

$$f_E = f_w + \frac{2\pi}{g} V f_w^2 \cos \mu$$

where  $f_w$  is wave frequency and  $V$  ship speed.

**Frequency of wave encounter, circular** (*seakeeping*) ( $\omega_E$ ) [ $T^{-1}$ ]

$$\omega_E = \frac{2\pi}{T_E} = 2\pi f_E$$

**Frequency, natural, of heave, pitch or roll of a ship** (*seakeeping*) ( $f_z, f_\theta$ , or  $f_\phi$ ) [ $T^{-1}$ ]

The frequency of the periodic heaving, pitching or rolling motion of a ship.

**Frequency, natural circular, of heave, pitch or roll** (*seakeeping*) ( $\omega_z, \omega_\theta$  or  $\omega_\phi$ ) [ $T^{-1}$ ]

Frequency, natural circular, of heave, pitch or roll has the following definitions respectively:

$\frac{2\pi}{T_z}$ ,  $\frac{2\pi}{T_\theta}$  and  $\frac{2\pi}{T_\phi}$ , where  $T_z$ ,  $T_\theta$  and  $T_\phi$  are the natural periods (which see).

**Fresh water, standard** (*performance*)

See: *Water, standard fresh*.

**Friction deduction force in self propulsion test** (*performance*) ( $F_D$ ) [ $LMT^{-2}$ ]

The towing force applied to a model to compensate for the increased specific frictional resistance of the model and to achieve the ship-point of self-propulsion.

**Frictional resistance** (*resistance*)

See: *Resistance*

**Frictional wake** (*performance*)

See: *Wake, frictional*.

**Froude number** (*hydrodynamics*) ( $Fr$ ) [-]

A dimensionless parameter expressing the conditions of dynamical similarity for flow systems

influenced by gravity and inertia alone. In particular it defines the speed at which geometrically similar models and ship will develop wave systems which are geometrically similar. It is given by:

$$Fr = \frac{V}{\sqrt{gL}}$$

The length term  $L$  is usually the length of the ship. Other forms of the Froude number use some other characteristic dimension, such as the cube root of volume of displacement, the submergence depth or the depth of water in restricted waterways.

**Fully cavitating propeller** (*propulsion, propulsor*)

See: *Propeller types*.

**Fully developed cavity** (*cavitation*)

A cavity formed on a body which terminates sufficiently far downstream so that the flow at the downstream region does not influence the body itself. For example, the cavity is fully developed when the re-entrant jet formed at the downstream end of the cavity is dissipated without impinging on the body. See also: *Supercavitating flows*.

# G

## **Gap** (*propulsion, propulsor*) ( $G_Z$ ) [L ]

The distance between the chord lines of two adjacent propeller blade sections measured normal to the chord. This distance is given by the formula:

$$G_Z = (2\pi r \sin\varphi)/Z$$

where  $r$  is the radius in question,  $\varphi$  is the pitch angle of the chord line at the radius  $r$  (geometric pitch) and  $Z$  is the number of blades.

## **Gas content** (*cavitation*) ( $\alpha$ )

The gas content of a liquid may be in either a dissolved or undissolved state. The quantity of dissolved gas will vary according to Henry's law, but it is now generally agreed that cavitation inception is associated with the gas contained in nuclei in an undissolved state (see: *Nuclei* and *Nucleation*). Total gas content is equal to both the dissolved and undissolved gas. "Free" and "entrained" gas content are alternate terms for *undissolved* gas content, but the latter term is preferred.

## **Gas content of the saturated liquid** (*cavitation*) ( $\alpha_S$ )

The gas content of the saturated liquid at standard temperature and pressure.

## **Gas content ratio** (*cavitation*) ( $a_S$ ) [-]

The ratio of the content (dissolved and undissolved) in a test liquid to the gas content of the saturated liquid at standard temperature and pressure:  $a_S = \alpha/\alpha_S$

## **Gas injection, protection by** (*cavitation*)

Small amounts of gas injected into the cavitating region to reduce the pressure through a

"cushioning" effect during compression by the collapsing cavitation bubbles.

## **Gaseous cavitation** (*cavitation*)

Depending upon the magnitude of the pressure reduction and the rate of application, a bubble may grow slowly by diffusion gas into the *nucleus* (which see) and contain mostly gas rather than vapour. Such bubble growth is defined as gaseous cavitation. Such cavitation may occur at pressure greater or less than vapour pressure aided by the process of *Rectified diffusion* (which see).

## **Gearing efficiency** (*performance*)

See: *Efficiency, gearing*.

## **Generator line** (*propulsion, propulsor*)

The line formed by the intersection of the pitch helices and the plane containing the shaft axis and the propeller reference line. The distance from the propeller plane to the generator line in the direction of the shaft axis is called the rake. The generator line, the blade reference line, and the propeller reference line each intersect the shaft axis at the same point when extended thereto. Because of ambiguities which can arise in so extending the generator line and blade reference line when non linear distribution of rake and skew angle are used, it is recommended that these lines be defined each to originate at the reference point of the root section (see Figure 4-6 and Figure 4-5). The rake and skew angle of the root section will thus be defined to be zero and the propeller plane will pass through the reference point of the root section.

**Figure 4-5: Diagram showing recommended reference lines (looking forward)**

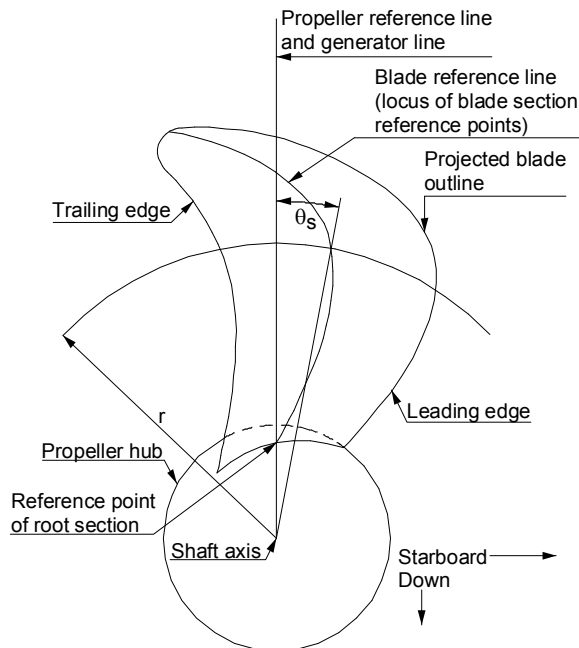

**Geometric angle of attack** (*propulsion, propulsor*)

See: *Angle of attack, geometric*

**Geometric pitch** (*propulsion, propulsor*)

See: *Pitch, geometric*

**Geosim** (*performance*)

One of a series of models which differ in absolute size but are geometrically similar. It is a contraction of the expression “geometrically similar model” and was first used by Dr. E. V. Telfer.

**Girth** (*ship geometry*) (-) [L]

The distance around the perimeter of any transverse station, section, or frame, between two selected points. For wetted surface calculations, these two points are generally the waterplane intersections.

**Gravitational acceleration** (*general*), (*g*) [L T<sup>-2</sup>]

The acceleration, due to earth’s gravity field, of a freely falling body in a vacuum. This is not strictly constant and over the earth’s surface it varies by as much as ½%. For most terrestrial engineering purposes it is usual to disregard this variation and for convenience the following international standard value has been agreed: 9.80665 m/s<sup>2</sup> (32.1737 ft/s<sup>2</sup>).

**Green water** (*seakeeping*)

Water shipped on the deck of a ship in heavy seas, as distinct from spray.

**Ground speed** (*performance*)

See: *Speed, ground*.

**Group velocity** (*seakeeping*)

The average rate of advance of the energy of a finite train of gravity waves.

**Gyradius (radius of gyration)** (*seakeeping*) (*k<sub>x</sub>, k<sub>xx</sub>, k<sub>y</sub>, k<sub>yy</sub>, k<sub>z</sub>, k<sub>zz</sub>*) [L]

The square root of the ratio of mass moment of inertia (referred to body axes) to the mass of a body. See: *Axes, co-ordinate*.

# H

**Half-siding** (*ship geometry*) (-) [L] (See Figure 2-4)

The half breadth, at any section, of the portion of the bottom, in the vicinity of the keel that is perpendicular to the centerplane, i.e. parallel to the baseline.

**Harmonic** (*seakeeping*)

Sinusoidal, in referring to a function or motion.

**Head** (*hydrodynamics*) ( $h$ ) [L]

The height of a given fluid which the pressure in question would support.

**Heading** (*manoeuvring, seakeeping, performance*) ( $\psi$ ) [ ]

The instantaneous direction of the projection of the forward longitudinal axis of a ship in a horizontal plane, defined by degrees of the compass or degrees azimuth. See Figure 7-4., *performance* :See also Fig.2-4

**Headreach** (*manoeuvring*)

See: *Advance, maximum (in stopping)*.

**Heaving** (*seakeeping*)

The vertical oscillatory motion of a specified point in a vessel, usually the centre of gravity. Although the heaving of a ship is a motion which is confined to operation in waves, it is possible with a high-speed planing craft for such motion to occur in calm water under some conditions. (See *Porpoising*)

**Heave to** (*seakeeping*)

To maintain control of a ship, especially in extremely heavy weather, with minimum possible speed through the water.

**Heel or list** (*manoeuvring, seakeeping*)

A steady inclination of a ship about a longitudinal axis; to be distinguished from rolling, which is an oscillatory motion.

**Heel or list, angle of** (*manoeuvring, seakeeping*) ( $\phi$ ) [-]

The angle, measured about a longitudinal axis, between a static inclined position of a ship and its normal upright position.

**Hub** (*propulsion, propulsor*)

The central portion of a screw propeller to which the blades are attached and through which the driving shaft is fitted. Also known as the boss.

**Hub diameter** (*propulsion, propulsor*) ( $d_h$ ) [L]

The diameter of the hub where it intersect the generator line.

**Hub cavitation** (*cavitation*)

See: *Hub vortex cavitation*.

**Hub ratio** (*propulsion, propulsor*) ( $x_B$ ) [-]

The ratio of the diameter of the hub to the maximum diameter of the propeller,  $d_h/D$ .

**Hub vortex cavitation** (*cavitation*)

Cavitation in the vortex produced by the blades of a propeller at the hub.

**Hull** (*ship geometry*)

The body of a ship, including the above water and the underwater portions. It is used to express either its form or its structure.

**Hull efficiency** (*performance*)

See: *Efficiency, hull*.



**Hull, naked** (*ship geometry*)

The condition of a ship or model in which the fair form and the surface are represented without appendages or additions of any kind; it is also called bare hull.

**Hydraulically smooth surface** (*performance*)

See: *Surface, smooth.*

**Hydrodynamic flow angle** (*propulsion, propulsor*)

See: *Angle, hydrodynamic flow.*

**Hydrodynamic pitch** (*propulsion, propulsor*)

See: *Pitch, hydrodynamic.*

**Hydrodynamic pitch angle** (*propulsion, propulsor*)

Synonymous with hydrodynamic flow angle.  
See: *Angle, hydrodynamic flow.*

**Hydrodynamic spindle torque** (*propulsion, propulsor*)

See: *Spindle torque, hydrodynamic.*

**Hydroelasticity** (*seakeeping*)

Analogous to aeroelasticity. The study of the interaction between the inertial, hydrodynamic and elastic forces in a structure subjected to hy-

drodynamic loading. Divided into dynamic hydroelasticity, where these three forces are co-existent, or static hydroelasticity where inertial forces are absent.

**Hydrofoil** (*propulsion, propulsor*)

A structure externally similar to an airplane wing designed to produce lift and which operates in water.

**Hydrofoil section** (*propulsion, propulsor*)

The cross-section shape of a hydrofoil.

**Hydrofoil, span** (*ship geometry*) (*b*) [L]

The length of a hydrofoil from tip to tip, from root to tip if cantilevered, or from end support to end support, measured normal to the direction of relative liquid motion.

**Hysteresis, cavitation** (*cavitation*)

Difference between critical cavitation numbers for incipient and desinent cavitation. Also, the difference between the angle of attack of a lifting surface for initiation or fully developed cavitation during angle of attack increase and the much lower angle of attack at which a fully developed cavity can still be maintained once it has been formed.

# I

**Ideal angle of attack** (*propulsion, propulsor*)

See: *Angle of attack, ideal.*

**Immersion** (*propulsion, propulsor*) ( $h_0$ ) [-]

The depth of submergence of the propeller measured vertically from the shaft axis to the free surface.

**Immersion ratio** (*propulsion, propulsor*) [-]

The depth of submergence of the propeller axis divided by propeller diameter.

**Impact** (*seakeeping*)

The sudden contact of body or ship, or any part thereof, with the surface of a liquid.

**Inboard rotation** (*propulsion, propulsor*)

A propeller which is not located on the centreline of the ship is said to have inboard rotation if the blade moves toward the centreline as they pass the upper vertical position. The opposite direction of rotation is called outboard rotation. Also called inward and outward rotation respectively.

**Inception of cavitation** (*cavitation*)

See: *Cavitation inception.*

**Inception cavitation number** (*cavitation*)

See: *Cavitation number, inception.*

**Inception pressure**

See: *Critical pressure.*

**Inception velocity** (*cavitation*)

See: *Critical velocity.*

**Incipient cavitation** (*cavitation*)

Cavitation which just begins with a slight change in ambient conditions: pressure decrease and/or velocity increase.

**Incubation zone** (*cavitation*)

In the sequence of cavitation erosion, the initial zone of the curve of weight loss versus time in which the material undergoes changes (e.g. work hardening in ductile metals) due to repeated bubble collapse pressures, but in which the material suffers little or no weight loss.

**Indicated power** (*performance*)

See: *Power, indicated.*

**Induced velocity, axial** (*propulsion, propulsor*) ( $U_A$ ) [ $LT^{-1}$ ]

The change in the velocity component in the direction parallel to the propeller axis due to the presence of the propeller but not including any change in the wake field due to propeller/hull interactions. Positive upstream.

**Induced velocity, radial** (*propulsion, propulsor*) ( $U_R$ ) [ $LT^{-1}$ ]

The change in the velocity component in the radial direction due to the presence of the propeller but not including any change in the wake field due to propeller/hull interactions. Positive outward.

**Induced velocity, tangential** (*propulsion, propulsor*) ( $U_T$ ) [ $LT^{-1}$ ]

The change in the velocity component in the tangential direction due to the presence of the propeller but not including any change in the wake field due to propeller/hull interactions. Positive clockwise looking forward.

**Intensity damage** (*cavitation*)

The power absorbed per unit eroded area of a specimen undergoing erosion.

**Intermittent cavitation** (*cavitation*)

A type of cavitation that respectively originates and disappears from a discrete point on a solid surface.

**Internal jets** (*cavitation*)

Jets sometimes formed by the unsymmetrical collapse of transient cavities. Also sometimes called *microjets*.

**Inward rotation** (*propulsion, propulsor*)

See: *Inboard rotation*.

**Irrotational flow**

See *Flow, potential*.

# J

**Jet cavitation** (*cavitation*)

Cavitation formed in the low pressure eddies associated with the turbulent fluctuations in the high shear region of jet flows.

# K

## **Keel** (*ship geometry*)

The term is used, alone or characterised with an appropriate adjective, to indicate:

- i. The intersection of the plane of symmetry with the moulded hull surface at the bottom which is called the “keel line”. It may be parallel to the designed waterline or may be raked or sloped in the fore and aft direction.
- ii. The keel as the central longitudinal girder. This may be of the flat type (Flat keel) or a heavy bar extending beyond the fair form of the bottom (Bar keel – See Figure 2-11).

Appendages to improve the directional stability or reduce rolling: Bilge keel, an appendage, generally in the form of one or more long narrow fins, fitted along the side of a ship at the turn of the bilge to reduce rolling (See Figure 2-11).

## **Keel, fin** (*ship geometry*)

A deep, relatively thin, generally fixed plate or hydrofoil, attached to the underside of a ship (generally a sailing ship), to reduce the leeway and improve the directional stability. This fin

keel can be on, or parallel to, the longitudinal centreplane.

**Figure 2-11: Bilge and bar keels**

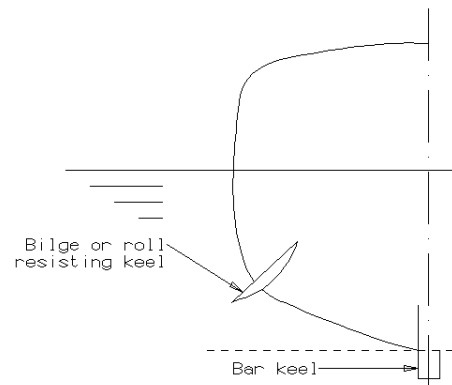

## **Knuckle** (*ship geometry*)

See: *Chine*.

## **Kort nozzle** (*propulsion, propulsor*)

See: *Propeller types (ducted)*.

# L

**Laminar cavitation** (*cavitation*)

See: *Sheet cavitation*.

**Laminar sublayer** (*hydrodynamics*)

See *Sublayer, laminar*.

**Leeward side of a ship** (*ship geometry*)

The side of a ship opposite to that the wind blows. It is opposite to the windward side.

**Leeway** (*seakeeping*)

The down wind or down sea motion of a ship. More specifically, the lateral distance the ship has been forced off the desired path.

**Leeway angle** (*seakeeping*)

See: **Drift, angle of**.

**Left handed propeller** (*propulsion, propulsor*)

A propeller which rotates in the counterclockwise direction when viewed from astern.

**Length** (*ship geometry*) ( $L$ ) [L] (See Figure 2-12)

The principal longitudinal dimension of a ship or body; specifically for a ship it can be defined in a number of ways as follows:

**Length overall** ( $L_{OA}$ ) [L]

**Length overall submerged** ( $L_{OS}$ ) [L]

**Length between perpendiculars** ( $L_{PP}$ ) [L]

**Length on waterline** ( $L_{WL}$ ) [L]

When not defined, the length between perpendiculars is generally assumed. See also *Amidships* for  $\infty$  and *Perpendiculars* for AP and FP. For a planing hull the following definitions of length are used: (See Figure 2-13)

Figure 2-12: Characteristic ship lengths

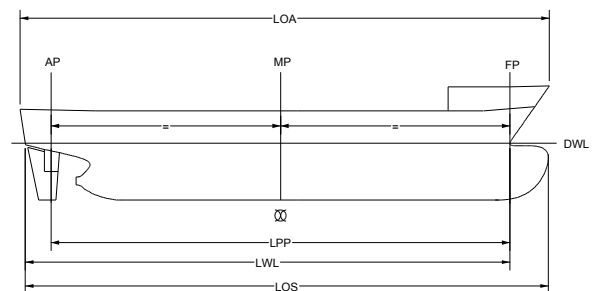
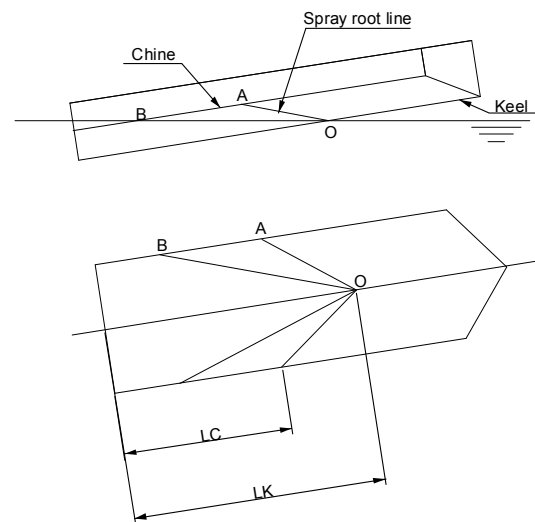

Figure 2-13: Characteristic lengths for a planing hull under way



**Length, chine wetted under way of planing craft** (*ship geometry*) ( $L_C$ ) [L]: the length of the wetted part of the chine

**Length, keel wetted under way of planing craft** (*ship geometry*) ( $L_K$ ) [L]: the length of the wetted part of the keel

**Length, mean wetted, of planing craft** (*ship geometry*) ( $L_M$ ) [L]: the mean length of the portion of the bottom of a planing craft actually wetted when under way

$$L_M = \frac{L_C + L_K}{2}.$$

**Length, projected chine** (*ship geometry*) ( $L_{PR}$ ): Length of chine projected in a plane containing the keel and normal to longitudinal centre plane (See Figure 2-3 and Figure 2-2).

**Length coefficient of Froude, or length – displacement ratio** (*ship geometry*) ( $M_C$ ) [-]  
 The ratio of the ship length to the cube root of the volume of displacement:

$$M_C = \frac{L}{\nabla^{\frac{1}{3}}}$$

in a consistent system of units.

**Lift** (*propulsion, propulsor*) ( $L$ ) [MTL<sup>2</sup>]  
 The fluid force acting on a body in a direction perpendicular to the motion of the body relative to the fluid.

**Lift coefficient** (*manoeuvring*) ( $C_L$ ) [-]  
 A relationship between the lift force  $L$  developed by a ship or body and the dynamic pressure times a specified area. It is customary to express it as  $C_L = L/qA$ .

**Line, equipotential** (*hydrodynamics*)  
 See *Equipotential line*.

**Lines** (*ship geometry*)  
 A drawing, depicting the form of a ship to the moulded shape and dimensions, showing the stations (transverse section or frames) waterlines, bowlines, buttocks and profile. (This includes a *Body Plan* which see.)

**List** (*seakeeping*)  
 See: *Heel*

**Load factor** (*performance*) ( $1+x$ ) [-]  
 See: *Power prediction factor*.

**Load fraction in power prediction** (*performance*) ( $x$ ) [-]

$$x = \eta_D \frac{P_D}{P_E} - 1$$

where  $P_D$  and  $P_E$  are the delivered and effective powers respectively and  $\eta_D$  the quasi-propulsive efficiency (which see).  
 See also: *Power prediction factor*.

**Long crested seas** (*seakeeping*)  
 A wave system in which all components advance in the same direction.

**Lurch** (*seakeeping*)  
 A more or less isolated large roll amplitude.

# M

**Maierform** (*ship geometry*)

A commercial name applied to a certain type of hull form with pronounced V sections at the fore end.

**Manoeuvrability** (*manoeuvring*)

Manoeuvrability is that quality which determines the ease with which the speed, attitude and direction of motion of a body can be changed or maintained by its control devices.

**Manoeuvring** (*manoeuvring*)

The process of executing various voluntary evolutions with a ship, such as starting, stopping, backing, steering, turning, diving, rising, circling, zigzagging, dodging and the like.

**Mass, added** (*manoeuvring, seakeeping*)

See: *Added mass*

**Mass, added, coefficient** (*manoeuvring, seakeeping*)

See: *Added mass coefficient*.

**Maximum transverse section coefficient** (*ship geometry*)

See: *Sectional area coefficient*.

**Mean chord length** (*propulsion, propulsor*)

See: *Chord length, mean*.

**Mean line** (*propulsion, propulsor*)

The mean line is the locus of the midpoint between the upper and lower surface of an airfoil or hydrofoil section. The thickness is generally measured in the direction normal to the chord rather than to the mean line. The maximum distance between the mean line and the chord line, measured normal to the chord line, is called the

camber. The term camber line is often used synonymously with mean line.

**Mean pitch** (*propulsion, propulsor*)

See: *Pitch, mean*.

**Mean width ratio** (*propulsion, propulsor*) [-]

Mean expanded or developed chord of one blade divided by the propeller diameter. Equal to the inverse of one half the aspect ratio for a wing.

**Measured course** (*performance*)

See: *Course, measured*.

**Mechanical efficiency** (*performance*)

See: *Efficiency, mechanical*.

**Median line** (*propulsion, propulsor*)

Synonymous with generator line.

**Metacentre, transverse ( $M$ ) and longitudinal ( $M_L$ )** [-] (*ship geometry*)

The intersection of the vertical through the centre of buoyancy of an inclined body or ship with the upright vertical when the angle of inclination approaches to zero as limit, for transverse or longitudinal inclinations respectively.

**Metacentre** (*ship geometry*), **transverse and longitudinal; height above the baseline,  $\overline{KM}$  and  $(\overline{KM}_L)$  respectively** [L].

The height, measured vertically, of the transverse or longitudinal metacentre above the baseplane of a ship in the upright position.

**Metacentre height, transverse ( $\overline{GM}$ ) and longitudinal ( $\overline{GM}_L$ )** [L].

The distance between the centre of gravity and the transverse or longitudinal metacentre, measured



vertically in the equilibrium position. It is positive when M is above G when the ship is said to have metacentric stability; that is, on inclination to a small angle a restoring moment arises which acts to return the ship to the vertical.

**Metacentric radius, transverse ( $\overline{BM}$ ) and longitudinal ( $\overline{BM}_L$ )** [L]. The height, measured vertically, of the transverse or longitudinal metacentre above the centre of buoyancy of a ship in the upright position. Geometrically,  $\overline{BM}$  is the radius of curvature of the locus of the centre of buoyancy related to transverse inclinations, and  $\overline{BM}_L$  the radius of curvature of the locus of the centre of buoyancy related to longitudinal inclinations. They are given by:

$$\overline{BM} = \frac{I_T}{\nabla}$$

$$\overline{BM}_L = \frac{I_L}{\nabla}$$

where:

$I_T$  = transverse second moment of area (or moment of inertia) of the waterplane [ $L^4$ ] (which see)

$I_L$  = longitudinal second moment of area (or moment of inertia) of the waterplane [ $L^4$ ] (which see)

$\nabla$  = volume of displacement [ $L^3$ ]

(See Figure 2-14 for illustration of the transverse parameters.)

**Figure 2-14: Transverse metacentric parameters**

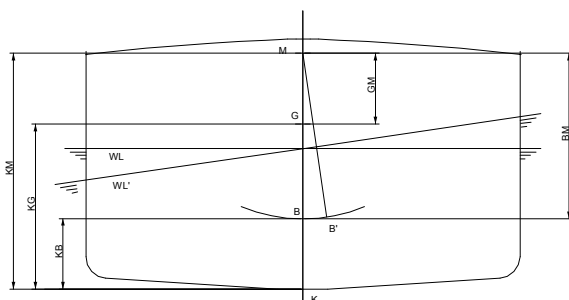

**Microjets (cavitation)**

See: *Internal jets.*

**Midship (ship geometry)**

See: *Perpendiculars*

**Midship section coefficient (ship geometry)**

See: *Sectional coefficient*

**Midstation plane (ship geometry)**

See: *Planes, principal co-ordinate*

**Mile, measured. (performance)**

See: *Course measured.*

**Modulus of elasticity, volume or bulk (general), (E)** [ $L^{-1} M T^{-2}$ ]

The ratio of the stress, or force per unit area, to the corresponding change of volume per unit volume.

**Moment of area, second (or moment of inertia) (ship geometry)** [ $L^4$ ]

The summation of the products of the elements of an area or surface squares and the squares of their distances from a given axis, generally in the surface. Especially for a ship:

**Second moment of the waterplane area (or moment of inertia) longitudinal ( $I_L$ )** about the transverse axis through the centre of flotation.

**Second moment of the waterplane area (or moment of inertia), transverse ( $I_T$ )** about the longitudinal axis through the centre of flotation, generally the intersection of the intersection of the waterplane and the centerplane.

**Second moment of free-water surface (or moment of inertia)** generally within a ship, calculated about an axis passing through the centre of area of that surface, parallel to the expected heeling or rolling axis.

**Moment, damping (seakeeping)**

A moment which tends to reduce the motion and, if assumed to be linear, is proportional to the angular velocity.

**Moment, destabilising (seakeeping)**

A moment associated with a displacement from a position of equilibrium and tending to increase this displacement.

**Moment, exciting** (*seakeeping*)

A fluctuating external moment that causes motion of a body or ship when encountering a train of waves.

**Moments of inertia or roll, pitch and yaw moment of inertia** (*seakeeping*) ( $I_X, I_{XX}, I_Y, I_{YY}, I_Z, I_{ZZ}$ ) [ $L^2M$ ]

The summation of products of elementary masses and the squares of their distances from the respective body axes through the centre of gravity – equal to the mass times the square of the *gyradius* or *radius of gyration* (which see). See General Section for body axes under *Axes, co-ordinate*.

**Moment, pitching** (*seakeeping*)

Exciting moment in pitch.

**Moment, restoring or righting** (*seakeeping*)

A moment tending to return a body to its initial condition after being displaced by an external moment.

**Moment, rolling** (*seakeeping*)

Exciting moment in roll.

**Moment, stabilising** (*seakeeping*)

Moment associated with a displacement from a position of equilibrium and tending to decrease this displacement.

**Moment, turning** (*manoeuvring*)

A moment applied to a ship to cause it to assume angular dynamic motion about a vertical axis through the centre of gravity.

**Moment, wave bending, horizontal or lateral** (*seakeeping*) ( $M^B_3$  or  $M_L$ , formerly  $M_{BH}$ ) [ $L^2MT^{-2}$ ]

That part of the inertial lateral bending moment acting on a cross section of a hull which is

caused by the action of waves and ship motions.

**Moment, wave bending, vertical** (*seakeeping*) ( $M^B_2$  or  $M_N$ , formerly  $M_{BV}$ ) [ $L^2MT^{-2}$ ]

That part of the internal vertical bending moment acting on a cross section of a hull which is caused by the action of waves and ship motions.

**Moment, wave, torsional** (*seakeeping*) ( $M^T$  or  $M_T$ ) [ $L^2MT^{-2}$ ]

That part of the internal torsional or twisting moment acting on a cross section of a hull which is caused by the action of waves and ship motions.

**Moment, yaw** (*manoeuvring*) ( $N$ ) [ $L^2MT^{-2}$ ]

A hydrodynamic moment due to environmental conditions acting on a ship which will tend to produce yawing in the form of an angular dynamic motion about the vertical or *z*-axis through the centre of the ship.

**Motions, ship** (*seakeeping*)

The all inclusive term to describe the various dynamic motions which may be made by a ship including the following which are defined separately:

- i. *Rolling, Pitching* and *Yawing* (angular)
- ii. *Heaving, Surfing* and *Swaying* (translatory)

These motions may occur while the ship is stationary in the water or travelling through it.

**Moulded** (*ship geometry*)

An adjective used to indicate the generally fair form and dimensions of the hull as determined by the lines to the inside of the shell plating. For wooden ship it is taken to the outside of the planking.

# N

**Natural period of motions: heave, pitch, roll** (*seakeeping*) ( $T_z, T_\theta, T_\phi$ ) [T]

The time for one complete cycle of the motion resulting when a body or ship is displaced in calm water from its equilibrium position by an external force, then released.

**Neutral angle** (*manoeuvring*)

The angle between any characteristic line or plane of a body or ship and any other intersecting line or plane taken as reference, when the forces, moments or other actions on or by the body or ship have a value of zero.

**Nominal pitch** (*propulsion, propulsor*)

See *Pitch, nominal*.

**Non-stationary cavities** (*cavitation*)

Free-streamline (cavitating) flows in which the cavity size is a function of time. The cavity surface is a boundary surface, but not necessarily a stream surface. Cavities trailing a body entering a water surface are characteristic of non-stationary cavities.

**Nose-tail line** (*propulsion, propulsor*)

Synonymous with chord line.

**Nozzle** (*propulsion, propulsor*)

The duct portion of a ducted propeller. Synonymous with duct or shroud.

**Nucleation** (*cavitation*)

The process of formation of nuclei in liquid. Also, sometimes used to refer to the process of stabilisation of nuclei to account for their persistence in undersaturated and saturated liquids.

**Nucleus, nuclei** (*cavitation*)

Small bubbles, often sub-microscopic in size, containing permanent gas and/or the vapour of the liquid, which are required for inception of cavitation at the pressure near vapour pressure. (See also: *Nucleation*).

**Number, Froude** (*hydrodynamics*)

See *Froude number*.

**Number, Reynolds** (*hydrodynamics*)

See *Reynolds number*.

# O

**Offset** (*ship geometry*)

One of a series of distances, measured from reference planes (normally from the centerplane), used for defining the size and the shape of a body or ship.

**Ogival section** (*propulsion, propulsor*)

A type of an airfoil or hydrofoil section having a straight face, a circular arc or parabolic back, maximum thickness at the mid chord, and relatively sharp leading and trailing edges.

**Onset cavitation** (*cavitation*)

See: *cavitation inception*

**Orange peel surface appearance** (*cavitation*)

Description of a surface moderately damaged by the cavitation in which the appearance is that of the surface of the Jaffa or California orange.

**Oscillator** (*seakeeping*)

A mechanism used to impose a controlled, known, oscillatory motion on a body. Also used to describe any oscillatory body.

**Outboard rotation** (*propulsion, propulsor*)

A propeller which is not located on the centreline of the ship is said to have outboard rotation

if the blades move away from the centreline as they pass the upper vertical position. The opposite direction of rotation is called inboard rotation. Also called outward and inward rotation respectively.

**Outward rotation** (*propulsion, propulsor*)

See: *Outboard rotation*.

**Overhang** (*ship geometry*)

Any portion of the abovewater hull of a ship which when projected downward on to the designed waterplane, lies outside that designed waterline; it may be at the bow or stern or anywhere along the side.

**Overload fraction** (*performance*)

See: *Power prediction factor*.

**Overshoot** (*manoeuvring*)

A state of motion of a body or liquid in which, following a disturbance of the equilibrium conditions, the body or liquid returns toward equilibrium and passes beyond it, because of kinetic energy stored up in the system as it passes through the equilibrium position (See Figure 7-10). See also: *Zigzagging*.

# P

**Partial cavities** (*cavitation*)

Quasi-steady cavities that extend only partially along the bodies about which they are formed.

**Period** (*seakeeping*) ( $T$ ) [T]

The time for one complete cycle of a periodic quantity or phenomenon. (See also: *Natural period of motions*).

**Perpendiculars** (*ship geometry*) (See Figure 2-12)

Straight lines perpendicular to the designed load waterline of a ship through a fixed point as stated by classification rules: specially:

**Aft or after perpendicular** (AP). Through a fixed point at the stern; generally the aft side of the stern post, or centerline of the rudder stock in ship without a stern post.

**Fore or forward perpendicular** (FP). Through a fixed point at the bow; generally the intersection of the fore side of the stem with the load waterline.

Midship perpendicular or midship (MP, formerly  $\infty$ ).

Through the point in the middle of  $L_{PP}$ .

**Phase angle** ( $\varepsilon_i$ ) [-](*seakeeping*)

The angle between two vector representing sinusoidal quantities of the same frequency.

**Phase response operator** (*seakeeping*)

Phase angle between output and input of a linear system performing forced motion, as a function of frequency.

**Pitch** (*propulsion, propulsor*) ( $P$ ) [L]

The pitch of a propeller blade section at the radius  $r$  is given by:  $= 2\pi r \tan\varphi$ , where  $\varphi$  is the angle between the intersection of the chord line

of the section and a plane normal to the propeller axis. This angle is called the pitch angle. Also called geometric pitch (which see).

**Pitch analysis** (*propulsion, propulsor*)

Advance per revolution at zero thrust as determined experimentally.

**Pitch angle** (*propulsion, propulsor manoeuvring*) ( $\theta$ ) [-]

The angle, measured about the transverse body axis, between the instantaneous position of the longitudinal axis of a ship when pitching (which see) and its position of rest. (Positive bow up) See: *Pitch*.

**Pitch, effective** (*propulsion, propulsor*)

Weighted value of geometric pitch when pitch is not constant. Both the radius and the thrust distribution (if known) have been used as weighting factors.

**Pitch, face** (*propulsion, propulsor*)

The pitch of a line parallel to the face of the blade section. Used only for flat faced sections where offsets are defined from a face reference line.

**Pitch, geometric** (*propulsion, propulsor*)

The pitch of the nose-tail line (chord line). It is equal to the face pitch if the setback of the leading and trailing edges of the section are equal.

**Pitch, hydrodynamic** (*propulsion, propulsor*)

The pitch of the streamlines passing the propeller including the velocities induced by the propeller at a radial line passing through the mid-chord of the root section. See: *Angle, hydrodynamic flow*.

**Pitch angle** (*seakeeping*) ( $\theta$ ) [-]

The angle, measured about the transverse body axis, between the instantaneous position of the longitudinal axis of a ship when *pitching* (which see) and its position of rest. (Positive bow up).

**Pitching** (*manoeuvring, seakeeping*)

The angular component of the oscillatory motion of a hull about a transverse axis. Although pitching of a ship is a motion confined to operation in waves, it is possible with a high-speed planing craft for such motions to occur in calm water under some conditions. (See: *Porpoising*)

**Pitch, mean** (*propulsion, propulsor*)

- i. Generally synonymous with the effective pitch.
- ii. The pitch of a constant pitch propeller which would produce the same thrust as a propeller with radially varying pitch when placed in the same flow.

**Pitch, nominal** (*propulsion, propulsor*)

Synonymous with face pitch. (See: *Pitch, face*).

**Pitch ratio** (*propulsion, propulsor*) ( $p$ ) [-]

The ratio of the pitch to the diameter of the propeller. Generally, the face pitch or geometric pitch at the 70 percent radius is used to compute the pitch ratio. Any measure of pitch can be used with the diameter to form a pitch ratio.

**Pitch, variable** (*propulsion, propulsor*)

A propeller blade for which the pitch is not the same at all radii is said to have variable pitch or varied pitch. A propeller which has the same pitch at all radii is said to be a constant pitch propeller. (*propulsion, propulsor*)

**Pitted surface appearance** (*cavitation*)

Description of a surface damaged by cavitation in which pits are formed either by crater-like deformation (especially as in lead) without loss of material or by actual loss of material following work hardening or fatigue.

**Planes, principal co-ordinate** (*ship geometry*)

The co-ordinate planes, formed by an orthogonal co-ordinate system of axes  $x, y, z$  fixed in the ship to define the hull shape (see *Axes, co-ordinate* in *General Section*):

**Baseplane or x-y plane.** The horizontal plane, parallel to the designed waterline and generally through the lowest point of the midsection.

**Centreplane or x-z plane.** The vertical longitudinal plane, which coincides with the plane of symmetry.

**Plane, midstation, or y-z plane.** The vertical plane at midstation, perpendicular to the baseplane and the centreplane or plane of symmetry.

**Plane rotation** (*propulsion, propulsor*)

See: *Propeller plane*.

**Plane of symmetry** (*ship geometry*)

See: *Planes, principal co-ordinate*.

**Plane, transverse** (*ship geometry*)

Any vertical plane orthogonal to the baseplane of a ship.

**Planform, projected** (*ship geometry*)

The contour of a ship, a hydrofoil, or appendage projected orthogonally on to a plane parallel to the baseplane.

**Porpoising** (*manoeuvring, seakeeping*)

The cyclic oscillation of a high-speed craft primarily in clam water in which heaving motion is combined with pitching motion. The motion is sustained by energy drawn from the thrust.

**Positional motion stability** (*manoeuvring*)

See: *Stability, course*

**Potential flow** (*hydrodynamics*)

See *Flow, potential*.

**Potential function or Velocity potential**

(*hydrodynamics*) ( $\phi$ ) [ $L^2 T^{-1}$ ]

In irrotational motion of a fluid, the velocity at any point may be derived from a single function  $\phi$  such that its derivative with respect to dis-

tance in any direction is equal to the velocity component in that direction. See also *Flow, potential*.

**Potential wake (performance)**

See: *Wake, potential*.

**Pounding (seakeeping)**

Described broadly as impacting between a water surface and the side or bottom of a hull. Pounding can perhaps be differentiated from slamming in that the impact, while heavy, is not in the nature of a shock. (See: *Slamming*)

**Power, brake (performance) ( $P_B$ ) [ $L^2MT^{-3}$ ]**

The power measured at the engine coupling by means of mechanical, hydraulic or electrical brake.

**Power coefficient, delivered (propulsion, propulsor) ( $K_P$ ) [-]**

The delivered power at the propeller,  $P_D$ , expressed in coefficient form:

$$K_P = P_D / \rho n^3 D^5$$

where  $\rho$  is the mass density of the fluid,  $n$  is the rate of the propeller rotation, and  $D$  is the diameter of the propeller.

**Power coefficient, Taylor's (propulsion, propulsor) ( $B_P$ )**

The horsepower absorbed by the propeller,  $P_D$ , expressed in coefficient form:

$$B_P = n (P_D)^{1/2} / (V_A)^{5/2}$$

where  $n$  is revolution per minute and  $V_A$  is the speed of advance in knots.

**Power coefficient, Taylor's ( $B_U$ ) (propulsion, propulsor)**

The thrust horsepower delivered by the propeller,  $P_T$ , expressed in coefficient form:

$$B_U = n (P_T)^{1/2} / (V_A)^{5/2}$$

where  $n$  is the revolution per minute and  $V_A$  is the speed of advance in knots.

**Power, delivered (performance) ( $P_D$ ) [ $L^2MT^{-3}$ ]**

The power delivered to the propeller:

$$P_D = 2\pi n Q$$

**Power, effective (performance) ( $P_E$ ) [ $L^2MT^{-3}$ ]**

The power required to tow a ship, usually without its propulsive device, at constant speed  $V$  in unlimited undisturbed water:

$$P_E = R_T V$$

The power may be for ship either with or without appendages. If the latter, it is usually known as the naked or bare hull, effective power.

**Power, indicated (performance) ( $P_I$ ) [ $L^2MT^{-3}$ ]**

The power developed in the cylinders of a reciprocating engine, either steam or diesel, as determined from the pressure measured by an indicator or similar device.

**Power loading coefficient ( $C_P$ ) [-]**

The power absorbed by the propeller,  $P_D$ , expressed in coefficient form:

$$C_P = \frac{P_D}{\frac{\rho}{2} V_A^3 (D^2/4)} = (K_Q/J^3)(8/\pi)$$

where  $\rho$  is the fluid density,  $V_A$  is the speed of advance, and  $D$  is the propeller diameter. This coefficient may be defined in terms of the ship speed  $V$  and is then denoted by the symbol  $C_{PS}$ .  $K_Q$  and  $J$  are the torque and advance coefficient respectively (which see).

**Power prediction factor (performance) ( $1+x$ ) [-]**

A factor based on the correlation of ship and corresponding model data, which is introduced in estimating ship power to allow for the method of extrapolating model results to ship, scale effects on resistance and propulsion and the effects of hull roughness and weather conditions such that:

$$P_D = \frac{P_E(1+x)}{\eta_D}$$

where  $P_D$  and  $P_E$  are the delivered and effective powers respectively and  $\eta_D$  the quasi-propulsive efficiency (which see).

The results of model propulsion experiments are analysed for a propeller loading equivalent

to the power prediction factor. The factor  $(1+x)$  is sometimes known as the *load factor* and the factor  $x$  as the *load fraction* (which see).

**Power, shaft (performance) ( $P_S$ )** [ $L^2MT^{-3}$ ]  
 The power delivered to the shafting system by the propelling machinery.

**Power, thrust (performance) ( $P_T$ )** [ $L^2MT^{-3}$ ]  
 The power developed by the propeller thrust  $T$ , at the speed of advance  $V_A$ :

$$P_T = TV_A$$

**Power in waves, mean increase in (performance, seakeeping) ( $P_{AW}$ )** [ $L^2MT^{-3}$ ]  
 The mean increase in power in wind and waves as compared with the power in still water at the same mean speed.

**Pressure, dynamic (hydrodynamics) ( $q$ )** [ $L^1MT^{-2}$ ]  
 The pressure change corresponding to the reduction of the momentum of a fluid element to zero,  $q = \frac{1}{2}\rho U^2$ .

**Pressure side (propulsion, propulsor)**  
 The side of the propeller blade having the greater mean pressure during normal ahead operation. Synonymous with the face of the blade. Analogous to the lower surface of a wing.

**Pressure, stagnation (hydrodynamics)** [ $L^1MT^{-2}$ ]  
 The total pressure measured at a stagnation point.

**Pressure, impact (seakeeping)**  
 A local pressure experienced by a hull when subjected to impact with the water. Usually associated with *slapping*, *slamming* or *pounding* (which see)

**Pressure, static (hydrodynamics) ( $p$ )** [ $L^1MT^{-2}$ ]  
 The static pressure,  $p$ , at a point in a stream flow is that which would be recorded by a pressure gauge advancing with the speed of the local fluid and thus static with respect to it.

**Pressure, total (hydrodynamics)**  
 This is the sum of the static and dynamic pressures.

**Prismatic coefficient (ship geometry) ( $C_P$ , formerly  $\phi$ )** [-]  
 The ratio of the volume of displacement to the volume of the cylinder having the length  $L$  and cross section of the maximum section of the ship. This sometimes called the longitudinal prismatic coefficient and is given by:

$$C_P = \nabla / (LA_X)$$

The prismatic coefficient can also be referred to the different parts of ship, such as afterbody, forebody, entrance and run. In any case the assumed length, as well as the cross section area if different from the above, is to be clearly indicated.

**Prismatic coefficient, vertical (ship geometry) ( $C_{VP}$ , formerly  $\phi_V$ )** [-]  
 The ratio of the volume of displacement to the volume of a vertical cylinder having as horizontal section the waterline and as height the draught at midships. It given by:

$$C_{VP} = \nabla / (TA_W)$$

When different, the draught of the transverse section having maximum area is used ( $T_X$ ).

**Profile (ship geometry, manoeuvring)**  
 The outline of a ship when projected on the fore-aft vertical centreline plane; also the outline of parts of the ship, such as the stem, stern, and rudder, when similarly projected. For different shapes and types of stem and stern profile, see *Stem* and *Stern*.

Note: This definition also covers the contour of any flat or curved surface which acts as a hydrofoil or as a control surface; examples are the profiles of diving planes on submarines, fitted generally in a horizontal plane, and the profile of the blades on a screw propeller.

**Projected area (propulsion, propulsor)**  
 See: *Area, projected*.



**Projected area ratio** (*propulsion, propulsor*)  
( $a_p$ )[-]

The ratio of the projected area to the disc area.

**Propeller** (*propulsion, propulsor*)

Most generally, any device which will produce thrust to propel vehicle. The most common form is the screw propeller, which basically consists of a central hub and a number of fixed blades extending out radially from the hub. Lift is generated by the blades when the propeller is rotated. One component of the lift force produces the desired thrust and the other component creates torque which must be overcome by the engine to sustain rotation.

**Propeller efficiency** (*performance*)

See: *Efficiency, propeller.*

**Propeller-hull vortex cavitation** (*cavitation*)

Propeller tip vortex cavitation that extends intermittently to the surface of hull.

**Figure 4-6: Diagram showing recommended reference lines (looking to port)**

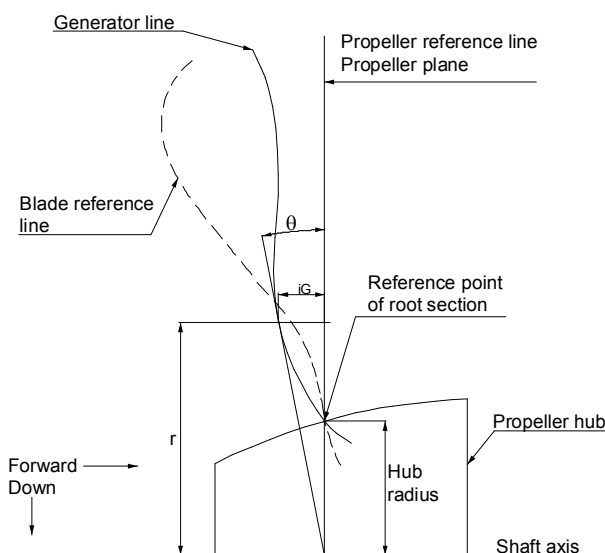

**Propeller plane** (*propulsion, propulsor*)

The plane normal to the shaft axis and passing through the intersection of the generator line and the shaft axis when the generator line is thereto extended. Also called the plane of rotation (See Figure 4-7 and Figure 4-6). It is recommended

that the plane be defined instead to contain the propeller reference line, i.e. contain the reference point of the root section, in order to avoid the ambiguities which can arise when non linear distributions of rake and skew are used.

**Propeller Types** (*propulsion, propulsor*)

**The basic screw propeller** may be described as fixed pitch, subcavitating, open (unducted), and fully submerged. Variations on this basic type are listed below.

**Adjustable-pitch propeller** - A propeller whose blades can be adjusted to different pitch settings when the propeller is stopped.

**Contrarotating propeller** - Two propeller rotating in opposite directions on coaxial shafts.

**Controllable pitch propeller** - A propeller having blades which can be rotated about a radial axis so as to change the effective pitch of the blade while the propeller is operating. This allows full power to be absorbed for all loading conditions. If the pitch can be adjusted to the extent that reverse thrust can be achieved without reversing the direction of rotation of the shaft then the propeller is sometimes called a controllable reversible pitch propeller.

**Cycloidal propeller** - A propeller consisting of a flat disc set flush with the under surface of the vessel with a number of vertical, rudder-like blades projecting from it. The disc revolves about a central axis and each of the blades rotates about its own vertical axis. The axis of each blade traces a cycloidal path. The blade motion can be varied so as to produce a net thrust in any desired direction in a plane normal to the axis of rotation. It is used where excellent manoeuvrability is required.

**Ducted propeller** - A propeller with a short duct mounted concentrically with the shaft. The duct, or nozzle is shaped so as to control the expansion or contraction of the slipstream in the immediate vicinity of the propeller. In one form (the Kort nozzle) the flow is accelerated, whereas in the other

form (pump jet) the flow is decelerated. A pump jet is sometimes also defined as a ducted propeller with stator vanes regardless of whether the flow is accelerated or decelerated.

**Fully cavitating propeller** - A propeller designed to operate efficiently at very low cavitation numbers where a fully developed cavity extends at least to the trailing edge of the blade. The blade sections of such propellers have relatively sharp, leading edges for more efficient supercavitating operation and thick trailing edges for strength. Also known as supercavitating propeller.

**Interface propeller** - A propeller of the fully cavitating ventilated type designed to operate with only a portion of the full disc area immersed. These propellers are considered for high speed applications to vehicles such as surface effect ship where the appendage drag associated with the shafts and struts of a fully submerged propeller would result in a considerable increase in resistance. Also known as partially submerged or surface propellers.

**Ring propeller** - A propeller with a very short duct attached to the tips of the blades and rotating with the propeller. Also called a banded propeller.

**Steerable ducted propeller** - A ducted propeller in which the duct can be pivoted about a vertical axis so as to obtain a steering effect.

**Supercavitating propeller** - See: *Fully cavitating propeller*.

**Tandem propeller** - Two propellers fitted to the same shaft, one behind the other, and rotating as one.

**Ventilated propeller** - A propeller of the fully cavitating type, but with provision to introduce air into the cavities in order to achieve fully developed, stable cavities at lower speed than would otherwise be impossible.

**Vertical axis propeller** - Synonymous with cycloidal propeller.

**Propulsive coefficient or efficiency** (*performance*)

See: *Efficiency, propulsive*.

**Protective coating** (*cavitation*)

Metallic and non-metallic materials applied to reduce surface damage by cavitation. They may be welded, sprayed or bonded to the surface.

**Pseudo cavitation** (*cavitation*)

Growth and collapse of gas filled bubbles whose size is at all times in static equilibrium with the surrounding pressure field.

**Pulsating cavity** (*cavitation*)

A “pulsating” cavity is a ventilated cavity which exhibits self excited oscillations of the cavity surface as a resonance phenomenon of the gas-liquid (cavity-jet) system; i.e. for self sustained oscillations, the frequency of the volume changes due to travelling surface waves on the cavity wall (and, hence, corresponding pressure changes) must be equal to the natural frequency of the gas liquid system.

**Pumpjet** (*propulsion, propulsor*)

See: *Propeller Types (ducted)*

# Q

**Quasi-propulsive coefficient or efficiency**

*(performance)*

See: *Efficiency, propulsive.*

# R

**Race, propeller** (*propulsion, propulsor*)

The accelerated, turbulent column of water forming the outflow from a screw propeller.

**Radial induced velocity** (*propulsion, propulsor*)

See: *Induced velocity, radial*

**Radius** (*propulsion, propulsor*) ( $r$ )[L]

Radius of any point on propeller

**Radius of gyration** (*seakeeping*)

See: *Gyradius*.

**Rake** (*propulsion, propulsor*) ( $i_G$ ,  $R_k$  (ISO)) [L]

The displacement,  $i_G$ , from the propeller plane to the generator line in the direction of the shaft axis. Aft displacement is considered positive rake (See Figure 4-7 and Figure 4-6). The rake at the blade tip or the rake angle are generally used as measures of the rake.

**Rake angle** (*propulsion, propulsor*)

The rake angle is defined as:

$$\theta = \tan^{-1}[i_G(r)/r]$$

where  $r$  is the radius (See Figure 4-6).

**Rake, skew induced** ( $i_S$ ) [L]

The amount of axial displacement (rake) of a blade section which results when skew-back is used (See Figure 4-7). It is the distance, measured in the direction of the shaft axis, between the generator line and the blade reference line and is given by:  $r\theta_S \tan\phi$ , where  $r$  is the local radius,  $\theta_S$  is the local skew angle, and  $\phi$  is the local pitch angle. It is positive when the generator line is forward of the blade reference line.

**Rake total** (*propulsion, propulsor*) ( $i_T$ ) [L]

The sum of the rake and skew-induced rake (See Figure 4-7)  
**Raked Keel** (*ship geometry*)  
See: *Keel and Trim*.

**Ram bulb or bow** (*ship geometry*)

See: *Bulb and Stem*

**Rate of weight loss** (*cavitation*)

The primary criterion for cavitation erosion. The weight loss per unit time from a test specimen.

**Ratio, aspect** (*manoeuvring*) ( $\Lambda$ )[-]

The ratio between the span of a hydrofoil, measured at right angles to the liquid flow, to the chord  $c$  of the hydrofoil, in the direction of flow. When the chord varies in length across the span, the aspect ratio is the span  $b$  divided by the mean chord  $c$  obtained generally dividing the hydrofoil projected area  $A_P$  into the square of the span  $b$ , i.e.  $b^2/A_P$

**Figure 4-7: view of unrolled cylindrical sections at blade root and at any radius  $r$  of a right-handed propeller (looking down) showing recommended position of propeller plane.**

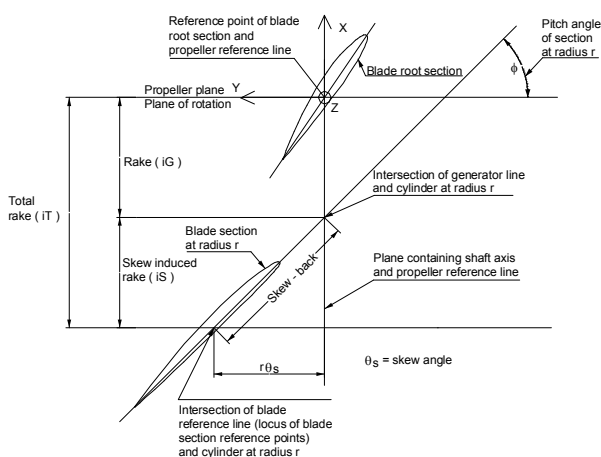

**Ratio, fineness, of a body** (*ship geometry*)

The ratio of the length  $L$  to the maximum diameter  $D$  of a body of revolution, or to the maximum breadth in other bodies.

**Ratio, slenderness, of a ship** (*ship geometry*) ( $M_C$ ) [-]

See: *Length coefficient of Froude*.

**Ratio, slip** (*performance*)

See: *Slip ratio*.

**Rectified diffusion** (*cavitation*)

Term applied to the net mass transport into a bubble of gas dissolved in a saturated liquid when the liquid is subjected to an oscillating pressure field.

**Re-entrant jets** (*cavitation*)

The re-entrant (upstream) flow at the trailing edge of steady (quasi-steady) cavities. Also, the re-entrant flow associated with the closure of non stationary cavities formed about missiles entering a water surface.

**Reference line, blade** (*propulsion, propulsor*)

The locus of the reference points of the blade sections (See Figure 4-6 and Figure 4-5). Sometimes used synonymously with generator line.

**Reference line, propeller** (*propulsion, propulsor*)

The straight line, normal to the shaft axis, which passes through the reference point of the root section (See Figure 4-6 and Figure 4-5). It lies in the plane containing the shaft axis and the generator line.

**Reference point, blade section** (*propulsion, propulsor*)

The point on the pitch helix to which the blade section offsets are referred. It usually the mid-point of the chord line. The point of maximum thickness and the location of the spindle axis for controllable pitch propeller, as well as other points, have also been used as blade section reference points.

**Relative mass or weight** (*general*), ( $\gamma$ ) [-]

The ratio of density of any substance to the density of fresh water at 4° Centigrade. In English speaking countries the concept expressed is called Specific gravity.

**Relative rotative efficiency** (*performance*)

See: *Efficiency, relative rotative*.

**Relative wind** (*performance*)

See: *Wind, relative*.

**Resistance** (*resistance*) ( $R$ ) [ $LMT^{-2}$ ]

The fluid force acting on a moving body in such a way as to oppose its motion; the component of the fluid forces acting parallel to the axis of motion of a body. Resistance is the preferred term in ship hydrodynamics, while drag is generally used in aerodynamics and for submerged bodies. Total resistance is denoted by  $R_T$  and various (not mutually exclusive) components of resistance are defined below. See also *Drag*.

**Resistance, appendages** (*performance*) ( $R_{AP}$ ) [ $LMT^{-2}$ ]

The increase in resistance relative to that of the naked, or bare hull resistance, caused by appendages such as bilge keels, rudders, bossings, struts, etc.

**Resistance augment fraction** (*performance*) ( $a$ ) [-]

The thrust  $T$  required to propel a model or ship at speed  $V$  is greater than the resistance  $R_T$  of the hull when towed at the same speed. The increase ( $T - R_T$ ) is called the augment of resistance, and the resistance augment fraction is:

$$a = \frac{T - R_T}{R_T}$$

$$T = (1 + a)/R_T$$

**Resistance coefficient** (*resistance*) ( $C_F$ ,  $C_R$ ,  $C_S$ ,  $C_T$ ,  $C_V$ ,  $C_W$ , etc.)[-]

The non dimensional ratio of any specific component of resistance per unit area, to the dynamic pressure far ahead of the body.

**Resistance coefficient, incremental, for model-ship correlation (performance) ( $C_A$ ) [-]**

The model-ship correlation allowance  $R_A$  (which see) expressed in coefficient form:

$$C_A = \frac{R_A}{\frac{1}{2}\rho V^2 S}$$

where  $\rho$  is the water density,  $V$  speed and  $S$  wetted surface.

**Resistance coefficient, wind (performance) ( $C_{AA}$ ) [-]**

The ratio between the air or wind resistance on a ship or body  $R_{AA}$ , and the force corresponding to the dynamic pressure times a specified area. It is customary to express it as :

$$C_{AA} = \frac{R_{AA}}{\frac{1}{2}\rho V_R^2 S}$$

Where  $A$  is the appropriate above water area of the ship,  $V_R$  the relative wind velocity (which see) and  $\rho$  the air density.

**Resistance, frictional (resistance) ( $R_F$ ) [ $\text{LMT}^{-2}$ ]**

The component of resistance obtained by integrating the tangential stresses over the surface of a body, in the direction of motion.

**Resistance, frictional specific (resistance) ( $C_F$ ) [-]**

An alternative name for the coefficient of frictional resistance, in which the reference area is taken to be the wetted area under consideration.

**Resistance, pressure (resistance) ( $R_P$ ) [ $\text{LMT}^{-2}$ ]**

The component of resistance obtained by integrating the normal stresses over the surface of a body in the direction of motion.

**Resistance, residuary (resistance) ( $R_R$ ) [ $\text{LMT}^{-2}$ ]**

A quantity obtained by subtracting from the total resistance of a hull, a calculated friction resistance obtained by any specific formulation.

**Resistance, roughness (performance) ( $R_{AR}$ ) [ $\text{LMT}^{-2}$ ]**

The increase in resistance relative to the resistance of a hydraulically smooth hull due to the effect of roughness. The hull roughness may be of different types such as:

**Structural roughness** caused by method of shell construction, waviness of plating, scoops, valve openings etc.

**Paint roughness** depending on the type of paint as well as how it is applied.

**Corrosion roughness** due to breakdown of the paint film and corrosion of the shell plating.

**Fouling roughness** caused by marine organisms depositing shell, grass etc.

**Resistance, spray (resistance) ( $R_S$ ) [ $\text{LMT}^{-2}$ ]**

The component of resistance associated with the expenditure of energy in generating spray.

**Resistance, still air (performance)**

See: *Resistance, wind*.

**Resistance in waves, mean increase in (seakeeping, performance) ( $R_{AW}$ ) [ $\text{LMT}^{-2}$ ]**

The mean increase in resistance in wind and waves as compared with the still water resistance at the same speed.

**Resistance, wave pattern (resistance) ( $R_{WP}$ ) [ $\text{LMT}^{-2}$ ]**

A resistance component deduced from measurements of wave elevations remote from ship or model where it is assumed that the sub surface velocity field, and hence the momentum of the fluid, can be related to the wave pattern by means of linearised theory. The resistance so deduced does not include wavebreaking resistance.

**Resistance, wavebreaking (resistance) ( $R_{WB}$ ) [ $\text{LMT}^{-2}$ ]**

A resistance component associated with the break down of the ship bow wave.

**Resistance, wavemaking** (*resistance*) ( $R_W$ ) [LMT<sup>-2</sup>]

The component of resistance associated with the expenditure of energy in generating gravity waves.

**Resistance, wind** (*performance*) ( $R_{AA}$ ) [LMT<sup>-2</sup>]

The fore and aft component of the resistance of above water form of a ship due to its motion relative to still air or wind. When there is no natural wind, this is called the still air resistance. See also: *Resistance coefficient, wind*.

**Resistance, viscous** (*resistance*) ( $R_V$ ) [LMT<sup>-2</sup>]

The component of resistance associated with the expenditure of energy in viscous effects.

**Resistance, viscous pressure** (*resistance*) ( $R_{PV}$ ) [LMT<sup>-2</sup>]

The component of resistance obtained by integrating the components of the normal stresses due to viscosity and turbulence. This quantity cannot be directly measured except for a fully submerged body when it is equal to the pressure resistance  $R_P$ .

**Resonance** (*seakeeping*)

The dynamical condition of a simple, uncoupled system where the excitation frequency is equal to the natural frequency.

Note: In a coupled system, the dynamic condition where the excitation frequency corresponds to the frequency of maximum response to unit exciting force over a range of frequencies.

**Response** (*seakeeping*)

The reaction of the system to an excitation.

**Response amplitude operator** (*seakeeping*)

The square of the ratio of response amplitude to excitation amplitude of a forced harmonic motion applied to a linear system, as a function of frequency.

**Response function** (*seakeeping*)

A complex function of which the modulus is equal to the response amplitude operator and

the argument is equal to the phase response operator.

**Restricted water** (*performance*)

See: *Water, restricted*.

**Revolutions, rate of, mean in waves** (*seakeeping, performance*) ( $n_{AW}$ ) [T<sup>-1</sup>]

The mean absolute increase in rate of revolutions (usually per minute), as compared with those in smooth water, necessary to maintain speed in wind and waves.

**Reynolds number** (*hydrodynamics*) ( $Re$ ) [-]

A dimensionless parameter expressing the condition of dynamical similarity for flow systems influenced by viscosity and inertia alone. For equal values of Reynolds number and the same orientation to the flow, the specific resistance coefficients of all geometrically similar smooth surfaces are identical as long as the uninfluenced speed field are similar and the flow is influenced by viscosity and inertia alone.

It is given by:

$$Re = \frac{VL\rho}{\mu} = \frac{VL}{\nu}$$

The length term  $L$  is usually the length of the surface, but the distance from the leading edge of the surface to a specific point, the diameter of a body, or the thickness of the boundary layer are sometimes used as length terms.

**Right handed propeller** (*propulsion, propulsor*)

A propeller which rotates in the clockwise direction when viewed from astern.

**Roll angle** (*manoeuvring, seakeeping*) ( $\phi$ ) [-]

The angle measured about the longitudinal body axis, between the instantaneous position of a ship when rolling (which see) and its normal upright position. (Positive starboard down).

**Rolling** (*manoeuvring, seakeeping*)

The angular component of the oscillatory motion of a hull about a longitudinal axis.

**Root** (*propulsion, propulsor*)

The part of the propeller blade adjacent to the propeller hub.

**Root cavitation** (*cavitation*)

Cavitation in the low-pressure region of the blade roots on a marine propeller.

**Rough surface** (*performance*)

See: *Surface, rough*.

**Roughness allowance** (*performance*) ( $\Delta C_F$ ) [-]

Now obsolescent, See: *Resistance coefficient, incremental for model-ship correlation* ( $C_A$ )

**Roughness, equivalent sand** (*performance*) ( $K_S$ ) [L]

Equivalent sand roughness is used as a convenient measure of the roughness of a surface and is determined by equating the frictional resistance of a surface of random roughness with that of a flat plate completely covered with sand grains of a sensibly uniform size as in Nikuradse's experiments. It is the average diameter of the Nikuradse sand grains.

**Roughness, height or magnitude** (*performance*) ( $k$ ) [L]

A length dimension expressing the height of a roughness element on a surface exposed to liquid flow. It is often expressed as some form of average such as root mean square or mean apparent amplitude.

**Roughness, resistance** (*performance*)

See: *Resistance, roughness*.

**Rudder** (*manoeuvring*)

A control surface, which by its action or movement, controls the steering or the turning of a ship in horizontal plane. Specifically, hinged or movable control-surface appendage in the form of a hydrofoil, placed either at the bow or at the stern of a ship, or at both ends, to apply a turning moment to the ship.

**Rudder** (*propulsion, propulsor*)

See Ship Geometry section.

**Rudder, active** (*propulsion, propulsor*)

A propulsion device installed in the rudder for ship manoeuvring at low or zero speed.

**Rudder angle** (*performance, manoeuvring*) ( $\delta_R$ ) [-]

The angular displacement of the rudder about its stock relative to the neutral position and measured in a plane normal to the stock. Positive when turning in the positive sense of rotation of the ship, regardless of the effect this angle may have on the ship. See also: *Control surface angle*.

**Rudder angle, ordered** (*manoeuvring, performance*) ( $\delta_{RO}$ ) [-]

The ordered angle set on the steering control apparatus. This may differ from the rudder angle  $\delta_R$ , depending on the lag and lost motion in the steering control and gear.

**Rudder area, total** (*manoeuvring*) ( $A_R, A_{RT}$ ) [ $L^2$ ]

The total lateral area of the rudder (including fixed and movable parts) measured in the reference plane (generally the plane of symmetry). See also: *Control surface area*.

**Rudder area, fixed** (*manoeuvring*) ( $A_X$ ) [ $L^2$ ]

The lateral area of the sole fixed part of the rudder. See also: *Control surface area*.

**Rudder area, movable** (*manoeuvring*) ( $A_{Rmov}$ ) [ $L^2$ ]

The lateral area of the sole movable part of the rudder. See also: *Control surface area*.

**Rudder directions** (*manoeuvring*)

Right or starboard rudder signifies that the main portion of the rudder aft of the stock has moved to the right or to starboard of the centreline, to cause the ship to turn to the right or to starboard in forward motion. Similarly, left or port rudder signifies movement in the opposite direction.

**Rudder post** (*manoeuvring*)

A vertical or nearly vertical member of the ship's structure upon which the steering rudder is hung or supported.



**Rudder span** (*manoeuvring*) ( $b_R$ ) [L]

The maximum distance from root to tip of the rudder.

**Rudder stock** (*manoeuvring*)

That portion of the rudder, concentric with the axis of rotation, which provides bearing support and also transmits the operating torque.

**Rudder, thickness ratio** (*manoeuvring*)

The ratio of the maximum thickness of any horizontal section of a rudder to the corresponding chord length.

**Rudder types** (*manoeuvring*)

See Figure 7-8

**Balanced or semi-balanced:** A control surface in the form of a swinging rudder in which a small fraction of the area, generally about one-fifth, is placed forward of the vertical turning axis to reduce the operating torque in the ahead direction.

**Compound:** A control device in the form of a fixed vertical appendage, to the after edge of which is hinged a movable or swinging rudder; see also: *Rudder, flap-type*.

**Contra:** A rudder with a curved blade, designed to be mounted abaft a propeller to take advantage of the rotation in the slipstream and to produce a forward thrust on the rudder.

**Flap:** A control device in the form of a moving rudder which is hinged for practically its entire vertical height to the hull, to a skeg, or to a fin which has an area large in proportion to that of the rudder. This type of rudder takes its name from the flaps on airplane wing; both function by building up large pressure differentials on the fixed parts of the ship or airplane to which they are attached.

**Offset:** A rudder which is offset from the centreplane of a ship either to port or starboard.

**Spade:** A control device in the form of a moving appendage which projects below the

stern of the ship without any fixed supports in front of it or below it.

Figure 7-8: Rudder types.

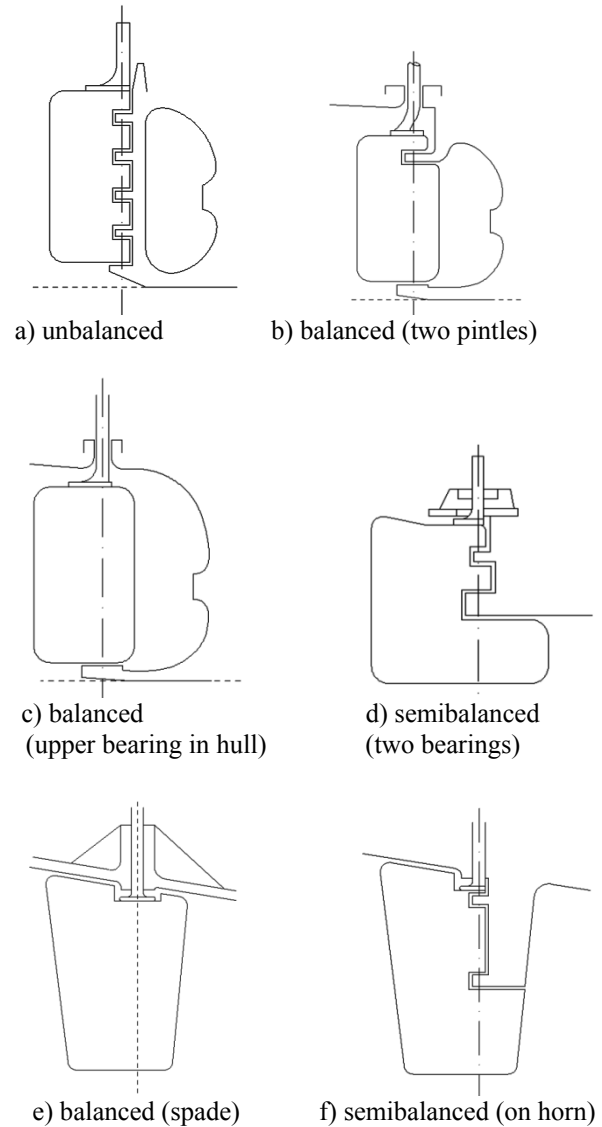

**Run** (*ship geometry*)

See: *Body*

**Run approach** (*performance*)

The path taken by a ship when accelerating during the approach to a measured course to attain a steady speed corresponding to give engine setting.

# S

## **Salt water, standard** (*performance*)

See: *Water, standard salt.*

## **Scale effect** (*performance*)

The change in any force, moment or pressure coefficients, flow pattern, or the like, due to a change in absolute size between geometrically similar models, bodies or ships. These variations in performance due to differences in absolute size arise from the inability to satisfy simultaneously all the relevant laws of dynamical similarity (e.g. gravitational, viscous and surface tension).

## **Scoop** (*ship geometry*)

An opening in the surface of the underwater body of a ship, which may or may not be fitted with a projection extending beyond that surface, designed for catching and taking water into a ship.

## **Screening effect** (*cavitation*)

Effect associated with the “screening” of nuclei by the pressure gradient about the body to which the nuclei are being convected, thus determining which nuclei will be repelled from and which nuclei will be swept into regions where the pressure are such as to enable cavitation inception to take place.

## **Screw propeller** (*propulsion, propulsor*)

See: *Propeller.*

## **Sea direction** (*seakeeping*)

**Beam sea** - A condition in which a ship and waves, or the predominant wave components, advance at right angles, or nearly so.

**Bow sea** - A condition in which a ship and the waves, or the predominant wave components, advance at oblique angles. This condi-

tion covers the direction between a head sea and beam sea.

**Following sea** - A condition in which ship and the waves, or predominant wave components, advance in the same, or nearly the same direction.

**Head sea** - A condition in which a ship and the waves, or the predominant components, advance in opposite, or nearly opposite directions.

**Quartering sea** - A condition in which a ship and the waves, or the predominant wave components, advance at oblique angles. This condition covers the directions between a beam sea and a following sea.

## **Seakeeping** (*seakeeping*)

In general, a term covering the study of the behaviour and performance of ship in a seaway. As an adjective, a term signifying a ship’s ability to maintain normal functions at sea.

## **Seakindliness** (*seakeeping*)

The quality of behaving comfortably in a seaway; that property of ship which produces easy motions in a seaway.

## **Section** (*ship geometry*)

The intersection of a plane with a body or ship which it passes through in any position or direction; specifically for a ship, any transverse section perpendicular to the designed waterplane such as:

Area, maximum section ( $A_X$ ) [ $L^2$ ]

Area, midship section, midlength section, midsection or midstation section ( $A_M$ ) [ $L^2$ ]

## **Section, ship shape** (*ship geometry*)

Any shape of transverse section considered typical in the development of ship forms. Some of this are:

**Blister** (See Figure 2-15 a)), in which an excrescence is added, near the waterline, to a more or less standard type of section.

**Bulb** (See Figure 2-15 b)), in which there is a local swelling below the waterplane generally at bow or stern. (For details and tions see special entry *Bulb*)

**Peg – top or battered** (See Figure 2-15 c)), in which there is a marked slope of the ship side outward and upward, generally but not necessarily above the designed waterline.

**U-shaped** (See Figure 2-15 d)), rounded at the bottom and with sensibly straight, nearly vertical sides.

**V-shaped** (See Figure 2-15 e)), relatively sharp at the bottom and with sensibly straight but flaring sides.

Figure 2-15: Typical shapes of transverse ship sections

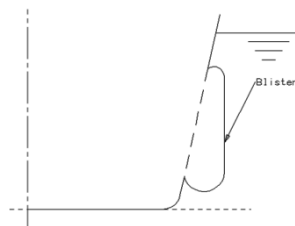

a) Blister

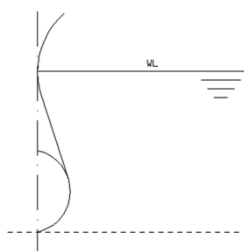

b) bulb

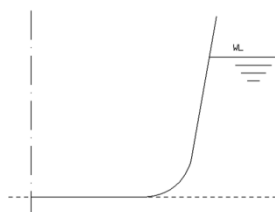

c) peg-top or battered

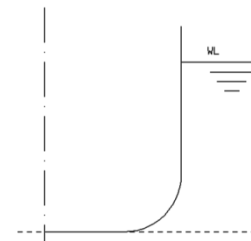

d) U shaped

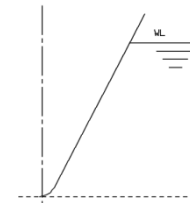

e) V shaped

**Sectional area coefficients** (*ship geometry*) ( $C_X$ ), ( $C_M$ , formerly  $\beta$ ) [-]

The *maximum transverse section coefficient*,  $C_X$ , is given by

$$C_X = \frac{A_X}{B_X T_X}$$

where  $A_X$  is the area of a maximum transverse section;  $B_X$  and  $T_X$  are the beam and draught at this section respectively.

The *midship section coefficient*  $C_M$  is given by

$$C_M = \frac{A_M}{B_M T_M}$$

where  $A_M$  is midship section area;  $B_M$  and  $T_M$  are the beam and draught at midship respectively.

**Sectional area curve** (*ship geometry*) (See Figure 2-16)

A diagram of transverse section areas up to the designed waterline plotted on a base of length  $L$ , representing the distribution of underwater volume along the length of a ship; this diagram may be made dimensionless by plotting each ordinate as the ratio of area  $A$  of any section to the area  $A_X$  of the maximum section and by plotting the position of that section as a fraction of a ship length  $L$  along the base from selected reference points (generally forward and after perpendicular or midships). The intercept of the tangent to the sectional area curve at the bow

on the midship ordinate expressed as a ratio of a midship ordinate is called the *Taylor tangent to the area curve or midperpendicular intercept ratio or terminal value of Taylor "t"*. If the sectional area at the end ordinate is not zero (e.g. when there is a bulbous bow) both intercept should be diminished by that area in evaluating  $t$ . The midperpendicular intercept ratio was originally related to the tangent at the forward perpendicular only, but it can also be referred to the after perpendicular; therefore, the terms  $t_E$  and  $t_R$  may be used to indicate respectively the *midperpendicular intercept ratio for entrance* and the *midperpendicular intercept ratio for run* respectively.

**Figure 2-16: Characteristics of sectional area curve**

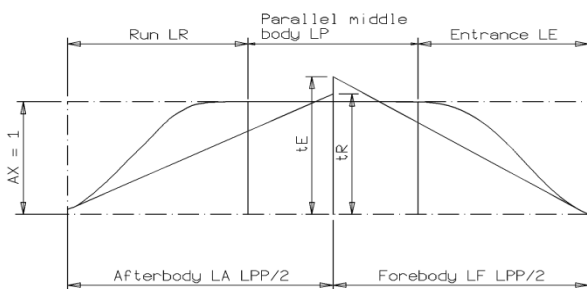

**Separation (hydrodynamics)**

See *Flow, separated*

**Set back (propulsion, propulsor) (-) [L]**

The displacement of the leading edge or trailing edge of a propeller blade section from the face pitch datum line when the section shape is referenced to that line. Also called wash-up. It is called wash-down if negative. The set back ratio is the set back divided by the chord length.

**Shaft bracket or strut (ship geometry)**

See: *Strut* or *Shaft bracket*.

**Shafting efficiency (performance)**

See: *Efficiency, shafting*.

**Shaft power (performance)**

See: *Power, shaft*.

**Shallow water (performance)**

See: *Water, shallow*.

**Sheer line (ship geometry)**

The projection on to the plane of symmetry of the intersection of deck with the side, or the intersection of a deck with the plane of symmetry of a ship. The amount of rise of a sheer line above its lowest point is called the *Sheer*, forward or aft.

**Sheet cavitation (cavitation)**

A term applied to describe relatively thin, steady or quasi-steady cavities. (Also, formerly called *laminar cavitation*)

**Shear stress (hydrodynamics) ( $\tau$ ) [ $L^{-1}MT^{-2}$ ]**

In a viscous fluid, the shear stress is the tangential resisting force per unit area acting on any boundary within the fluid. The specific value of the shear stress at a wall is denoted by  $\tau_w$ .

**Shock free entry (propulsion, propulsor)**

See: *Angle of attack, ideal*.

**Shoulder (ship geometry)**

The portion of a ship, at the junction of the middle body with the entrance or the run, where the waterlines approach or reach their maximum width.

**Short-crested sea (seakeeping)**

An irregular wave system in which the components advance in various directions.

**Shroud (propulsion, propulsor)**

The duct portion of a ducted propeller concentric with the axis of rotation of the propeller blades. In some cases the duct may be rotated about a vertical axis to provide steering forces. Synonymous: duct, nozzle.

**Sideslip (manoeuvring)**

The motion of a ship resulting from the propeller thrust, drag forces, hydrodynamic side forces on rudder and hull or centrifugal forces

in a turn, may have a component at right angles to the vertical plane through the longitudinal axis of the ship. This is called the sideslip. See also: *Drift*.

**Sideslip, angle of** (*manoeuvring, seakeeping*)  
See: *Drift or sideslip, angle of*.

**Sidewash** (*manoeuvring*)  
See: *Downwash*

**Significant wave height** (*seakeeping*)  
See: *Wave height, significant*.

**Sinkage** (*seakeeping*)  
The steady state lowering of a ship's position of flotation in the water; to be distinguished from heaving, which is an oscillatory motion.

**Singing** (*propulsion, propulsor*)  
Intense discrete frequency sound radiated from the propeller due to resonant vibrations of the blades. Generally thought to be due to the shedding of Karman vortices from the trailing edge of the blades at a resonant frequency of the blade vibration.

**Sink** (*hydrodynamics*)  
A point at which fluid is assumed to be withdrawn symmetrically from all directions. The velocity potential due to a sink has the same form as the potential due to a source, but the strength  $Q$  is negative. See also *Source*.

**Skeg** (*ship geometry, manoeuvring*)  
The thin portion of the hull at the stern of a vessel immediately forward of or in the vicinity of the rudder. A skeg is usually of large lateral area compared to its transverse thickness, is provided for the support of a propeller shaft, for structural strength, for docking support, for protection when grounding or to increase the lateral area and give increased roll damping and course keeping ability to the hull or for other reasons. It is placed generally at the aft end, but not necessarily on the centreline.

**Skew** (*propulsion, propulsor*) (-) [L]  
Synonymous with skew-back but sometimes used (incorrectly) to denote the skew angle.

**Skew angle** (*propulsion, propulsor*) ( $\theta_s$ ) [-]  
The angular displacement about the shaft axis of the reference point of any blade section relative to the generator line measured in the plane of rotation (See Figure 4-5 and Figure 4-7). It is positive when opposite to the direction of ahead rotation. This angle is the same as the warp. The skew angle at the blade tip is often used as a measure of the skew-back of a propeller.

**Skew-back** (*propulsion, propulsor*) (-) [L]  
The displacement of any blade section along the pitch helix measured from the generator line to the reference point of the section (See Figure 4-7). Positive skew-back is opposite to the direction of ahead motion of the blade section. Also called skew.

**Skew-induced rake** (*propulsion, propulsor*)  
See: *Rake, skew induced*.

**Slamming** (*seakeeping*)  
A phenomenon described broadly as severe impacting between a water surface and the side or bottom of a hull where the impact causes a shock-like blow. (See also: *Pounding* and *Whipping*).

**Slapping** (*seakeeping*)  
A phenomenon described broadly as light impact between the water and the hull. A classification for impacts less severe than those associated with pounding. (See also: *Pounding*).

**Slip ratio, apparent** (*performance*) ( $s_A$ ) [-]  
This is similar to the real slip ratio (which see) except that the ship speed  $V$  is used instead of the speed of advance  $V_A$ , that is:

$$s_A = \frac{Pn - V}{Pn} = 1 - \frac{V}{Pn}$$

**Slip ratio, real** (*performance*) ( $s_R$ ) [-]  
This is defined by the ratio:

$$s_R = \frac{Pn - V_A}{Pn} = 1 - \frac{V_A}{Pn}$$

where  $P$  is the nominal, geometrical pitch, or the effective pitch of the propeller (i.e. advance per revolution at zero thrust),  $V_A$  is the speed of advance and  $n$  the rate of propeller rotation.

**Slipstream** (*propulsion, propulsor*)

See: *Race*.

**Smith effect** (*seakeeping*)

The difference between actual pressure at a point under a wave profile and the static pressure corresponding to the actual distance below the surface.

**Smooth surface** (*performance*)

See: *Surface, smooth*.

**Solubility** (*general*),

The relative capability of being dissolved

**Sono-luminescence** (*cavitation*)

Visible light produced in the gas or vapour of cavities generated in the alternating pressure of an ultrasonic field. This phenomenon is believed to be associated with high temperatures resulting from compression of the gases within the bubble.

**Source** (*hydrodynamics*)

A point from which fluid is assumed to flow symmetrically in all directions. The strength  $Q$  of a source is defined in a three dimensional flow as the volume of fluid issuing in unit time; its dimensions are  $L^3T^{-1}$ . (Some authors use  $\sigma = Q/4\pi$  volume flow as source strength). A source at a point A generates at any point P a velocity potential:

$$\phi = -Q/(4\pi r)$$

where  $r = AP$ .

In a two dimensional flow parallel to a plane, a source at a point A is in fact a uniform distribution of sources on a straight line passing through A normal to the plane. The velocity potential due to such a source of strength  $Q$  is:

$$\phi = \frac{Q}{2\pi} \ln r$$

where  $r = AP$  and  $\ln =$  natural logarithm.

$Q$  is the volume of fluid issuing per unit time and per unit length in the direction normal to the plane. The dimension of  $Q$  is  $L^2 T^{-1}$ . An irrotational flow of perfect fluid may be represented as due to distributions of source and sinks, or doublets, on some set of points.

**Source, Kelvin** (*hydrodynamics*)

A Kelvin source is defined by the potential generated by a constant source in uniform rectilinear motion below the free surface of a perfect fluid.

**Span** (*propulsion, propulsor*) (b) [L]

The distance from tip to tip of a hydrofoil. The distance from root to tip is the semi-span.

**Specific** (*general*), As an adjective, often applies in English-speaking countries to the ratio between some quantity to be defined and a standard quantity having the same characteristics, which is taken as a reference. The best known term of this kind is the expression "specific gravity". Here the specific gravity is the dimensionless ratio of weight of unit volume of the designated substance to the weight of unit volume of fresh water. In other countries the term "specific" generally refer to absolute values per unit volume and is not expressed in terms of properties of a reference substance, such as water.

**Specific volume** (*general*), ( $L^3M^{-1}$ )

The volume of a substance per unit mass; the reciprocal of mass density (See: *Density*, *mass*)

**Specific weight or specific gravity** (*general*), (-) [-]

See: *Relative mass or weight*.

**Spectral density, one dimensional** (*seakeeping*) ( $S(\omega)$ )

A function of frequency whose integral over any interval represent the energy contribution

of all the component waves of a random function in that interval; the Fourier transform of the auto-covariance function.

$$S_{\zeta}(\omega)d\omega = \sum_{d\omega} \frac{1}{2} \zeta_{An}^2$$

$$S_{\theta}(\omega)d\omega = \sum_{d\omega} \frac{1}{2} \theta \zeta_{An}^2$$

etc.

The subscript  $n$  denotes a particular component amplitude.

**Spectral density, two dimensional** (*seakeeping*) ( $S(\omega, \mu)$ )

A function of frequency and wave direction whose integral over any interval represents the energy contribution of all the component waves of a random function in that interval.

**Spectrum** (*seakeeping*)

**Amplitude** - A function of frequency whose integral over any interval represents the squared amplitude of a wave at the central frequency having the same energy as all the component waves in that interval.

**Co-spectrum** - The real part of a *cross-spectrum* (which see).

**Cross-spectrum** - A complex function of frequency expressing the mutual properties of two random functions; the Fourier transform of the cross-covariance function, The real part, or co-spectrum, indicates the relationship between in-phase frequency components; the imaginary part, or quadrature spectrum, indicates the relation between 90° out-of-phase frequency components.

**Quadrature spectrum** - The imaginary part of a cross-spectrum.

**Speed, approach** (*manoeuvring*)

The speed of a body or ship along the straight approach path, just prior to entry into a turn.

**Speed, corresponding** (*performance*)

The speed of a ship  $V_S$  related to that of a model  $V_M$ , or vice-versa, according to Froude's Law of comparison:

$$V_S = V_M \sqrt{\lambda}$$

where  $\lambda$  is the scale factor.

**Speed, ground** (*performance*)

The speed of a ship relative to the ground, that is the speed including the effects of tide and currents. When the ship is moving through still water the ground speed is the same as the true water speed.

**Speed, hump** (*resistance*) (in high speed craft) [ $LT^{-1}$ ]

The speed at which the resistance reaches a maximum before a planing craft enters the planing phase, or a hydrofoil craft enters the foilborne phase.

**Speed loss** (*performance*)

The decrease in speed, as compared with that in smooth water, caused directly by wind and waves at a constant setting of the main propulsion plant. Usually speed loss is determined at constant power (turbine plant) or constant torque (diesel plant).

**Speed loss** (*seakeeping*)

The decrease in speed, as compared with that in smooth water, caused directly by wind and waves at a constant setting of the main propulsion plant. Usually speed loss is determined at constant power (turbine plant) or constant torque (diesel plant).

**Speed of advance** (*propulsion, propulsor*) ( $V_A$ ) [ $LT^{-1}$ ]

The translational speed of the propeller in relation to the body of water into which it is advancing. See also: *Performance Section*.

**Speed of advance of a propeller** (*performance*) ( $V_A$ ) [ $LT^{-1}$ ]

Speed of advance of a propeller in open water. When a propeller behind a ship or model is producing the same thrust at the same rate of rotation as in open water the corresponding speed  $V_A$  determined from the open water propeller characteristic is termed the speed of advance of the propeller. This is usually less than

the ship speed  $V$ . (See also: *Wake fraction, effective*). This is based on thrust identity. There is another corresponding speed based on torque identity.

**Speed reduction** (*seakeeping*)

The decrease in speed, as compared with that in smooth water, caused mainly by reducing the setting of the main propulsion plant in order to minimise the adverse effects on the ship of wind and waves. (*performance*) The decrease in speed, as compared with that in smooth water, caused mainly by reducing the setting of the main propulsion plant in order to minimise the adverse effects on the ship of wind and waves.

**Speed, true water** (*performance*)

The speed of a ship relative to the surrounding water.

**Spindle axis** (*propulsion, propulsor*)

The axis about which a controllable-pitch propeller blade is rotated to achieve a change in pitch.

**Spindle torque** (*propulsion, propulsor*) ( $Q_S$ ) [ML<sup>2</sup>T<sup>-2</sup>]

The torque acting about the spindle axis of a controllable-pitch propeller blade resulting from the hydrodynamic and centrifugal forces exerted on the blade. This torque is positive if tends to rotate the blade toward a higher positive pitch.

**Spindle torque, hydrodynamic** (*propulsion, propulsor*) ( $Q_{SH}$ ) [ML<sup>2</sup>T<sup>-2</sup>]

The torque acting about the spindle axis of a controllable-pitch propeller blade resulting from the hydrodynamic forces exerted on the blade. This torque is positive if it tends to rotate the blade toward a higher positive pitch.

**Spindle torque coefficient, centrifugal** (*propulsion, propulsor*) ( $K_{SC}$ ) [-]

The centrifugal spindle torque,  $Q_{SC}$ , expressed in coefficient form:

$$K_{SC} = Q_{SC}/(\rho_P n^2 D^5)$$

where  $\rho_P$  is the mass density of the propeller blade material,  $n$  is the rate of propeller rotation, and  $D$  is the propeller diameter.

**Spindle torque coefficient, hydrodynamic** (*propulsion, propulsor*) ( $K_{SH}$ ) [-]

The hydrodynamic spindle torque,  $Q_{SH}$ , expressed in coefficient form:

$$K_{SH} = Q_{SH}/(\rho n^2 D^5)$$

where  $\rho$  is the mass density of the fluid,  $n$  is the rate of propeller rotation, and  $D$  is the propeller diameter.

**Spindle torque index, hydrodynamic** (*propulsion, propulsor*) () [-]

The hydrodynamic spindle torque,  $Q_{SH}$ , expressed in coefficient form:

$$Q_{SH}/\left\{\frac{1}{2}\rho[V_A^2 + (0.7nD)^2]\right\}(\pi D^3/4)$$

where  $\rho$  is the density of the fluid,  $V_A$  is the speed of advance,  $n$  is the rate of propeller rotation, and  $D$  is the diameter. This form of the spindle torque coefficient is useful when presenting propeller spindle torque characteristics over a range of advance coefficient extending from zero ( $V_A = 0$ ) to infinity ( $n = 0$ ). Usually presented as a function of

$$\beta^* = \tan^{-1}[V_A/(0.7 n\pi D)]$$

**Spoiler** (*manoeuvring*)

Any device ancillary to a hydrofoil or control surface or stabiliser to disturb the flow, in order to diminish the lift.

**Spongy surface appearance** (*cavitation*)

Description of a surface badly damaged by cavitation in which erosion has taken place to a considerable depth and has the appearance of a sponge. This description is particularly characteristic of brittle materials and other materials after long exposure.

**Spot cavitation** (*cavitation*)

A general term for narrow quasi-steady cavities attached to a surface.



**Spray strip** (*ship geometry*)

A relatively narrow strip, of small cross-section, attached to the hull of a ship for the purpose of controlling or diverting spray.

**Spread** (*ship geometry*) (-) [L]

The transverse horizontal distance between the centreplanes or the other designed plane or line of the two hulls of a catamaran or other multi-hulled craft.

**Springing** (*seakeeping*)

The continuous ship-hull vibration induced by the non-impulsive hydrodynamic forces acting on the ship hull. In particular, the vibratory response of the ship hull girder to short waves with frequencies of encounter close to the lower structural modes of vibration of the ship. See also: *Whipping*.

**Stabiliser** (*seakeeping*)

Equipment to reduce the rolling (or pitching) motions of a ship.

**Stability** (*general*),

The property, quality, or characteristic of a body, which cause it, when its equilibrium is disturbed, to develop forces or moments acting to restore its original condition.

**Stability, course** (*manoeuvring*)

A body is said to have course stability if, when slightly disturbed from steady motion on a straight path, it returns to its original path, without any corrective control being applied. See Figure 7-4. Course stability in the horizontal plane does not normally exist, but a submarine can have it in the vertical plane. This is also known as *positional motion stability*.

**Stability, directional** (*manoeuvring*)

A body is said to be a directionally stable if, when slightly disturbed from steady motion on a straight path, it returns to its original direction, but not necessarily its original path, without any corrective control being applied. See Figure 7-4. Directional stability in the horizontal plane does not exist, but a submarine can have it in the vertical plane.

Note: The term directional stability is also commonly used to describe the more general case of straight-line stability (which see).

**Stability, dynamic** (*manoeuvring*)

A body is said to be dynamically stable on a straight course or on a turn constant curvature if, when slightly disturbed from a steady motion, it resume that same motion, but not necessarily along its original path, without any corrective control being applied. See Figure 7-9.

Figure 7-9: Illustration of stability items.

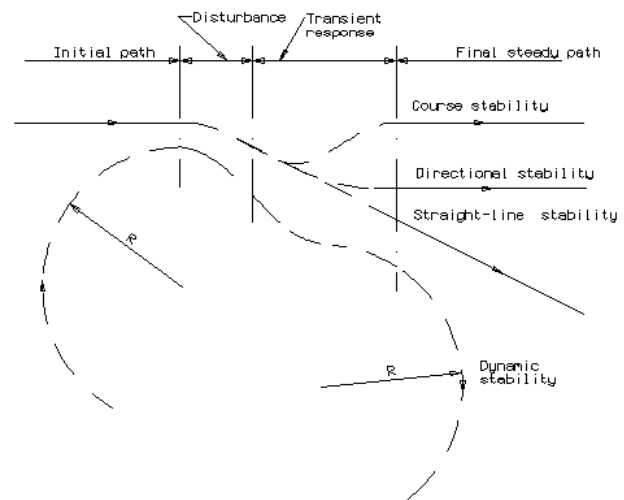

**Stability, straight-line** (*manoeuvring*)

A body is said to have straight-line stability if it is dynamically stable on a straight course. That is, when slightly disturbed from steady motion on a straight course, it resumes steady motion on a straight course, but not necessarily in its original direction, without any corrective control being applied. Figure 7-9.

Note: Straight-line stability is a special case of dynamic stability (which see); directional stability (which see) is a special case of straight-line stability; and course stability (which see) is a special case of directional stability.

**Stability, weathercock** (*manoeuvring*)

The directional or inherent stability of a body which is so restrained that its only freedom of motion is that of rotation about an axis perpendicular to the direction of relative liquid mo-

tion. The body tends to align itself with the direction of flow after being disturbed.

Note: In some quarters, as in wind tunnel establishments, this is also known as “static stability”.

**Stacking line** (*propulsion, propulsor*)

Synonymous with generator line. Also used to denote the blade reference line.

**Standard deviation** (*seakeeping*)

The square root of the average of the squares of the deviations from the mean value; the square root of the variance.

**Static thrust coefficient** (*propulsion, propulsor*)

See: *Thrust coefficient, static*

**Static** (*general*),

As an adjective, pertains to bodies or system at rest or forces in equilibrium; in this respect it is the opposite of *dynamic* (which see)

**Station** (*ship geometry*)

An imaginary transverse plane, passing through a ship, perpendicular to the baseline, to define the shape and the position of the various parts. Generally the length between perpendiculars is divided by intermediate stations into 10 or 20 equal intervals. Specifically:

**Maximum area station**, the station at which the transverse section has the maximum area;

**Midstation**, the station at midlength.

**Steady quasi-steady cavities** (*cavitation*)

Cavitating flow may be composed of individual transient cavities or of large cavities attached to the body on which cavitation has been induced (particularly if the detachment point is sharply defined, as for hydrofoil with sharp leading edge). The envelope of the bubbles in the former case and the cavities in the latter case are quasi-steady in the sense that envelope or cavity surface is stationary on a temporal average.

**Steady state** (*general*),

This applies to a condition may be static, but is generally dynamic, in which there is no change with time. A ship moving in a straight line at uniform speed and a ship in a steady turn at uniform speed both represent steady state conditions.

**Steady zone** (*cavitation*)

In the sequence of cavitation erosion, the final zone of the curve of weight loss versus time, in which the rate of weight loss is nearly constant. (Also called *steady-state zone*).

**Steepness ratio, wave** (*seakeeping*)

See: *Wave steepness ratio*.

**Stem** (*ship geometry*)

The extreme forward end of a ship from the keel line to the top of the hull. Different names are given to various types and shapes and profile, such as:

**Clipper**, in which the stem profile forms a concave curve which projects forward above the designed waterline, which a relatively large overhang. (See Figure 2-17 a))

**Icebreaker**, in which the stem profile below the designed waterline slopes angle of much less than 45° which the baseplane. (See Figure 2-17 b))

**Raked**, a straight profile inclined forward. (See Figure 2-17 c)).

**Ram**, in which the underwater stem profile extends beyond the forward perpendicular. (See Figure 2-17 d), Figure 2-17 e) and also *Bulb*)

**Vertical** (plumb), a straight profile coinciding with, or almost coinciding with, the forward perpendicular. (See Figure 2-17 f))

Figure 2-17: Types of stem profile

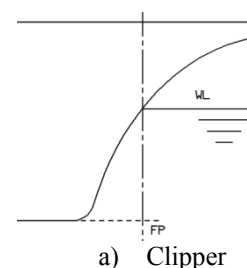

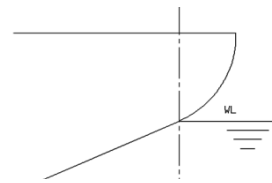

b) Icebreaker

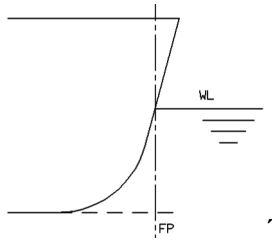

c) Raked

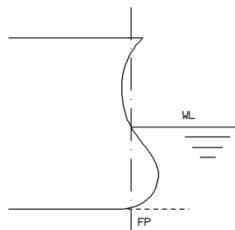

d) Ram bow

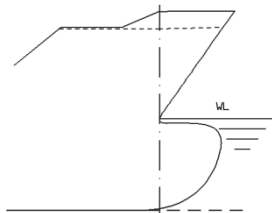

e) Bulbous bow

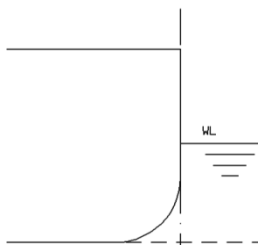

f) Vertical

**Steering or course keeping** (*manoeuvring*)

In its general sense, the guiding of vessel in a horizontal plane by a rudder or control device; specifically, keeping a vessel on, or as close as practicable to, a given or designated course, despite various disturbances. As distinguished from turning and manoeuvring, the term steering means keeping a vessel travelling in a given direction in a straight line.

**Step** (*ship geometry*)

The abrupt discontinuity in the profile of the bottom of a planing craft, designed to diminish resistance, to lessen the suction effects and to improve control of the longitudinal attitude. (See Figure 2-18)

Figure 2-18: Step in planing craft hull

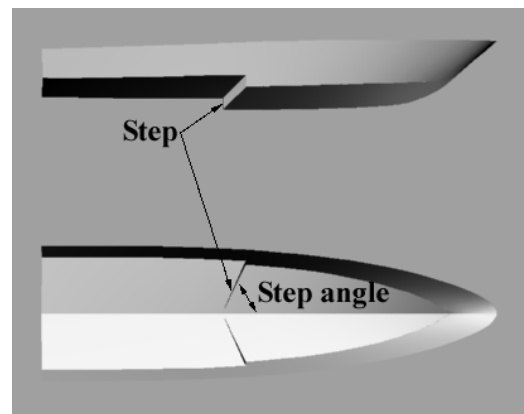

**Step angle** (*ship geometry*)

Angle projected upon the designed waterline, between the lower corner of a step or a planing craft and the centreline. (See Figure 2-18)

**Stern** (*ship geometry*)

The extreme after end of a ship from the keel line to the top of the hull. Different names are given to various types and shapes of stern profile, such as:

**Counter or fantail**, in which the deck extends abaft the rudder post forming an elongated extension with appreciable overhang. With this type of stern the deck line is generally broad and full, but the waterlines are generally fine. (See Figure 2-19 a))

**Steerable ducted propeller** (*propulsion, propulsor*)

See: *Propeller Types*.

**Cruiser**, in which the stern profile as a convex shape, as indicated in Figure 2-19 b).

**Transom**, in which the buttocks and the waterlines, above and below the designed waterline, terminate abruptly in a transverse flat or convex surface or transom. The transom may be vertical or slightly raking aft. (See Figure 2-19 c))

Figure 2-19: Types of stern profile

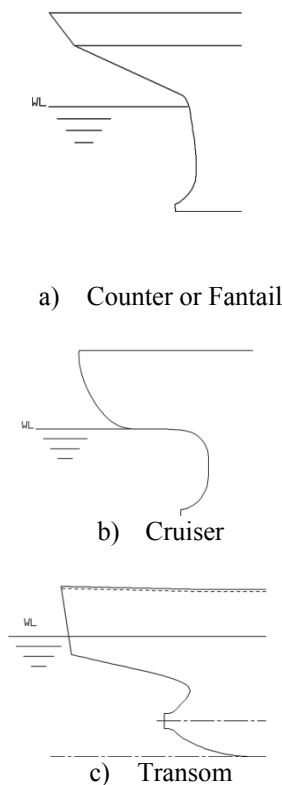

**Stern, contra type** (*ship geometry*)

A curved non symmetrical form of stern, or skeg ending just a head of a screw propeller, designed to impart a rotation to the propeller inflow against the direction of rotation of a propeller.

**Sternpost** (*ship geometry*)

A strong, rigid member forming the after end of the structure of some ships, and supporting the rudder.

**Sternwheel** (*ship geometry*)

A paddle-wheel mounted at the stern of a vessel which is called a stern-wheeler, as distinguished from a side wheeler.

**Stiffness** (*seakeeping*)

The property of a ship that causes a short rolling period.

**Still air resistance** (*performance*)

See: *Resistance, wind.*

**Stock** (*ship geometry*)

The shaft or spindle upon which a rudder, diving plane, or equivalent control surface is mounted. The rudder or plane is generally, but not necessarily, turned by the stock.

**Straight-line stability** (*manoeuvring*)

See: *Stability, straight line.*

**Streak cavitation** (*cavitation*)

Narrow quasi-steady cavities formed about excrescences or isolated roughness near the leading edge of a hydrofoil or other body. Such cavitation may also be associated with pressure variations in unstable laminar boundary layers.

**Stream-line** (*hydrodynamics*)

A line in a fluid such that its tangent at any point is parallel to the instantaneous velocity of the fluid at that point.

**Stream nuclei** (*cavitation*)

Undissolved gas nuclei existing in a stabilised condition (either on dust particles or otherwise) which are convected by the stream into regions of low pressure where they form cavitation sources.

**Strut or shaft bracket** (*ship geometry*) (See Figure 2-20)

A bracket supporting the outboard end of a propeller shaft in twin or multiple-screw vessels having propeller shaft fitted off the centreplane. This is sometimes referred to as an "A" bracket. It usually consists of a barrel fitted with a bearing for the shaft, connected to the shell by one or two streamlined arms (*Strut arms*)

**Strut-arm angle** (*ship geometry*) (See Figure 2-20)

The angle between the axis of any strut arm and the baseplane of a ship when projected on to a transverse plane.

**Strut-arm section angle** (*ship geometry*) (See Figure 2-20)

The angle between the meanline of a strut arm section normal to its axis at any selected point along the arm and a line lying in the plane of that section parallel to the centreplane or baseplane.

**Figure 2-20: Characteristics of propeller strut or shaft bracket**

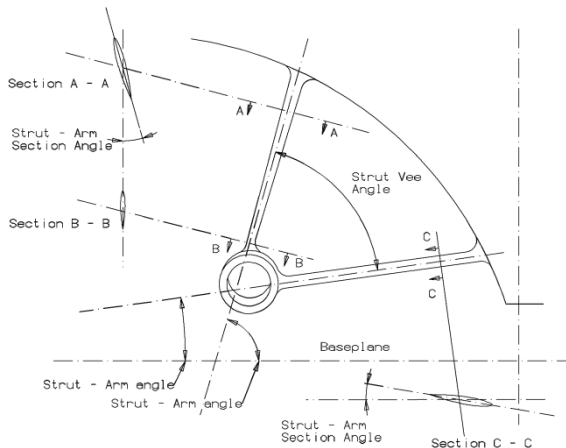

**Strut-vee angle** (*ship geometry*) (See Figure 2-20)

The angle between the axes of the two arms of a V-shaped strut, when projected on to a transverse plane.

**Sublayer, laminar** (*hydrodynamics*)

A very thin layer of laminar flow, within a turbulent boundary layer and adjacent to a solid surface.

**Submergence** (*seakeeping*) () [L]

The relative vertical distance of a part (usually the bow) of an oscillating ship below the water surface; opposite to emergence.

**Suction side** (*propulsion, propulsor*)

The low pressure side of a propeller blade. Synonymous with the back of the propeller blade. Analogous to the upper surface of a wing.

**Supercavitating flows** (*cavitation*)

Cavity flows in which attached, fully developed cavities extend beyond the trailing edge of the body about which the cavity is formed. (See also: *Attached cavities* and *Fully developed cavities*).

**Supercavitating propeller** (*propulsion, propulsor*)

See: *Propeller Types*.

**Supercavitation** (*cavitation*)

Term sometimes used as synonymous with *Supercavitating flow* (which see).

**Superventilation; Superventilated flow** (*cavitation*)

Terms analogous to *Supercavitating flow* to denote a ventilated flow in which the cavity extends beyond the trailing edge of the body about which the cavity is formed.

**Surface, rough** (*performance*)

A surface marked by sensible or visible irregularities

**Surface, smooth** (*performance*)

A surface free from irregularities sensible to the touch or visible to the naked eye. A surface is called hydraulically smooth when there is no increase of resistance due to the surface irregularities.

**Surface tension** (*general*),

The property of the interface between two immiscible fluids of behaving as if it were a film under tension.

**Surface, wavy** (*performance*)

A surface, which may be either smooth or rough, in which there are undulations of relatively large curvature.

**Surface, wetted** (*ship geometry*) ( $S$ ) [ $L^2$ ]

The surface area of the underwater body of a ship. This generally includes the area of the appendages which give an appreciable contribution to the frictional drag, such as bilge keel, propeller bossing, and rudder. It is usually expressed in non dimensional form viz:

i. Wetted surface coefficient ( $C_S$ ) [-]

$$C_S = S/\sqrt{\nabla L}$$

where:  $S$  = wetted surface area,  $L$  = ship length, and  $\nabla$  = volume of displacement or

ii. Froude's wetted surface coefficient ( $S_C$ ) [-]

$$S_C = S/\nabla^{2/3}$$

**Surging** (*seakeeping*)

The longitudinal oscillatory motion of a specified point in a ship, usually the centre of gravity (or origin of body axes).

**Swaying** (*manoeuvring, seakeeping*)

The transverse oscillatory motion of a specified point in the ship, usually the centre of gravity.

# T

## **Tab** (*manoeuvring*)

A small auxiliary foil, movable or fixed, attached to a control surface such as a rudder or diving plane, generally at its after edge, to reduce the control force or moment by applying local differential pressure to the main control surface.

## **Tangential induced velocity** (*propulsion, propulsor*)

See: *Induced velocity, tangential.*

## **Taylor's advance coefficient** (*propulsion, propulsor*)

See: *Advance coefficient, Taylor's*

## **Taylor's power coefficient** (*propulsion, propulsor*) ( $B_U, B_P$ )

See: *Power coefficient, Taylor's.*

## **Thickness, maximum** (*propulsion, propulsor*) ( $t$ ) [L]

The maximum thickness of a propeller blade section, generally measured to the chord line.

## **Thickness ratio** (*propulsion, propulsor*) ( $\delta$ ) [-]

The ratio of the maximum thickness,  $t$ , of a foil section to the chord length,  $c$ , of that section.

## **Thoma number** (*cavitation*) ( $Th$ ) [-]

The ratio of the difference between total head and the vapour pressure (upstream of the impeller of rotating machinery) to the total head produced or absorbed by the machine.

## **Thrust** (*propulsion, propulsor*) ( $T$ ) [MLT<sup>-2</sup>]

The force developed by a screw propeller in the direction of the shaft.

## **Thrust breakdown** (*propulsion, propulsor*)

The phenomenon of loss of thrust due to excessive cavitation on a subcavitating type propeller. The torque absorbed by the propeller is affected similarly and is called torque breakdown. Both the thrust and torque coefficient may increase slightly above noncavitating values near the initial inception of cavitation. In general, the changes in thrust and torque are such that propeller efficiency is reduced.

## **Thrust coefficient** (*propulsion, propulsor*) ( $K_T$ ) [-]

The thrust,  $T$ , produced by propeller expressed in coefficient form:

$$K_T = T / (\rho n^2 D^4)$$

where  $\rho$  is the mass density of the fluid,  $n$  is the rate of propeller rotation, and  $D$  is the propeller diameter.

## **Thrust coefficient, static** (*propulsion, propulsor*) () [-]

A figure of merit for comparing the relative performance of propulsion devices at zero speed given by the equation:

$$\frac{T}{(\rho \pi / 2)^{\frac{1}{3}} (P_D D)^{\frac{2}{3}}} = \frac{K_T}{\pi (K_Q)^{\frac{2}{3}} 2^{\frac{1}{3}}}$$

The ideal upper limit for unducted screw propellers is 1.0, while for ducted propellers the upper limit depends upon the area ratio of the downstream diffuser. When the area ratio is unity, i.e. no diffusion or contraction, the limit is  $2^{1/3} = 1.26$ ;  $\rho$  is the fluid density,  $D$  propeller diameter,  $P_D$  delivered power;  $K_T$  and  $K_Q$  are the thrust and torque coefficients respectively (which see).

**Thrust deduction factor (performance) ( $t$ ) [-]**

It is logical to view the effect of the propeller behind the hull as causing an increase in resistance- See: *Resistance augment fraction*. However, it is also common practice to look upon this increase in  $R_T$  as a deduction from the thrust  $T$  available at the propeller, i.e. to assume that of the total thrust  $T$  only  $R_T$  is available to overcome resistance. This "loss of thrust" ( $T - R_T$ ), expressed as a fraction of the thrust  $T$ , is called the thrust deduction fraction,  $t$ , where

$$t = \frac{T - R_T}{T}$$

or

$$R_T = (1 - t)T$$

**Thruster (propulsion, propulsor)**

A propulsion device for zero or low speed manoeuvring of vessels.

**Thrust index (propulsion, propulsor) ( $C_{T^*}$ ) [-]**

The thrust,  $T$ , produced by the propeller expressed in coefficient form:

$$C_{T^*} = \frac{T}{\frac{1}{2}\rho[V_A^2 + (0.7nD)^2](\pi D^2/4)}$$

where  $\rho$  is the density of fluid,  $V_A$  is the speed of advance,  $n$  is the rate of rotation and  $D$  is the propeller diameter. This form of the thrust coefficient is useful when presenting propeller thrust characteristics over a range of advance coefficients from zero ( $V_A = 0$ ) to infinity ( $n = 0$ ). Usually presented as a function of

$$\beta^* = \tan^{-1}[V_A/(0.7\pi nD)]$$

**Thrust in waves, mean increase in (seakeeping) ( $T_{AW}$ ) [MLT<sup>-2</sup>]**

The mean increase in thrust, as compared with that in smooth water, necessary to maintain speed in wind and waves.

**Thrust loading coefficient (propulsion, propulsor) ( $C_{Th}$ ) [-]**

The thrust,  $T$ , produced by the propeller expressed in coefficient form:

$$C_{Th} = \frac{T}{\frac{\rho}{2}V_A^2 \frac{\pi D^2}{4}} = \frac{K_T}{J^2} \frac{8}{\pi}$$

where  $\rho$  is the mass density of the fluid,  $V_A$  is the speed of advance,  $D$  is the propeller diameter, ( the symbol  $C_{TS}$  is used when this coefficient is based on ship speed instead of speed of advance).

Where  $K_T$  and  $J$  are the thrust and advance coefficient respectively (which see).

**Thrust power (performance)**

See: *Power, thrust*.

**Tilt (ship geometry)**

An inclination of ship or its parts from the vertical or upright position, generally in a transverse or athwartship plane.

**Tip cavitation (cavitation)**

Surface cavitation which occurs near the tip propeller blade.

**Tip vortex cavitation (cavitation)**

Cavitation occurring in the low-pressure core of the tip vortex of a hydrofoil or propeller.

**Toe angle of an offset rudder (manoeuvring)**

See: *Angle, toe, of an offset rudder*.

**Torque (propulsion, propulsor) ( $Q$ ) [ML<sup>2</sup>T<sup>-2</sup>]**

The torque delivered to the propeller aft of all bearings.

**Torque breakdown (propulsion, propulsor)**

See: *Thrust breakdown*.

**Torque coefficient (propulsion, propulsor) ( $K_Q$ ) [-]**

The torque,  $Q$ , delivered to the propeller expressed in coefficient form:

$$K_Q = \frac{Q}{\rho n^2 D^5}$$

where  $\rho$  is the density of the fluid,  $n$  is the rate of propeller rotation, and  $D$  is the propeller diameter.



**Torque index** (*propulsion, propulsor*) ( $C_{Q^*}$ ) [-]  
 The torque,  $Q$ , absorbed by the propeller expressed in coefficient form:

$$C_{Q^*} = \frac{Q}{\frac{1}{2}\rho[V_A^2 + (0.7nD)^2](\pi D^3/4)}$$

where  $\rho$  is the density of fluid,  $V_A$  is the speed of advance,  $n$  is the rate of rotation and  $D$  is the diameter. This form of the torque coefficient is useful when presenting propeller torque characteristics over a range of advance coefficients from zero ( $V_A = 0$ ) to infinity ( $n = 0$ ). Usually presented as a function of

$$\beta^* = \tan^{-1}[V_A/(0.7\pi nD)].$$

**Torque in waves, mean increase in** (*seakeeping*) ( $Q_{AW}$ ) [ $ML^2T^{-2}$ ]

The mean increase in torque as compared with that in smooth water, necessary to maintain speed in wind and waves.

**Torque or moment, hinge or stock, of a control surface** (*manoeuvring*) ( $Q_R$ ,  $Q_{FB}$ ,  $Q_{FS}$ , etc.) [ $L^2MT^{-2}$ ]

The torque applied to the stock or actuating mechanism of a control surface by the hydrodynamic forces acting upon it. Also the torque applied to the control surface through the stock or actuating mechanism to change the position or attitude of that surface, e.g. rudder torque  $Q_R$ , bow fin torque  $Q_{FB}$ , stern fin torque  $Q_{FS}$ , etc.

**Total gas content** (*cavitation*)

See: *Gas content*.

**Total rake** (*propulsion, propulsor*)

See: *Rake, total*.

**Towing force, for model at ship-point of self-propulsion** (*performance*)

See: *Force, model towing*.

**Tow point** (*manoeuvring*)

The point at which the towing force is applied on a ship which is towing or on a craft which is being towed.

**Track** (*performance*)

The path along which the centre of gravity of a ship is moving (See Fig. 24).

(*manoeuvring*) The path at which the centre of gravity of a ship is moving. See Figure 7-4.

**Trail, trailing** (*manoeuvring*)

As applied to a movable appendage or control surface, that condition in which the surface aligns itself with the surrounding flow, leading end foremost when all control force or moment is removed. An unbalanced rudder pivoted at its forward edge always trails when going ahead.

**Trailing vortex cavitation** (*cavitation*)

Persisting cavitation in the low-pressure core of trailing vortices downstream of hydrofoils or propellers. (See also: *Tip vortex cavitation* and *Hub vortex cavitation*).

**Transfer** (*manoeuvring*)

The lateral offset of the CG of a body or ship in the first quadrant of turn, measured laterally from the extended approach path to the CG position when the body or ship has changed course 90 degrees. See Figure 7-1.

**Transfer maximum** (in stopping)

The lateral offset of the centre of gravity of a body or ship before coming to rest after having executed a crash-back manoeuvre from a steady, straight-line motion ahead. See Figure 7-2

**T Transfer function** (*seakeeping*)

See: *Response function*.

**ransient** (*seakeeping*)

Irregular or non-harmonic, such as the free vibration of a damped mechanical system.

**Transient cavities** (*cavitation*)

Cavitation bubbles that grow from nuclei, sometimes oscillate (if containing a high volume of permanent gas component) and eventually collapse and disappear.

**Transom** (*ship geometry*)

See: *Stern*

**Trapped gas** (*cavitation*)

Undissolved gas trapped in the cavities of foreign particles or the crevices of the boundary under study.

**Trial, measured mile** (*performance*)

A trial carried out on a measured mile course to determinate the performance characteristics of a ship, namely ship speed, corresponding rate of rotation of propeller shaft, power, and also thrust where practicable.

**Trim** (*ship geometry*) (-) [L]

The difference between the draught forward  $T_F$  and the draught aft  $T_A$  for a ship with a designed level keel:

$$\text{Trim} = T_F - T_A$$

In non dimensional form the trim is expressed as a fraction of the ship length, i.e.  $(T_F - T_A)/L$  and is called the trim ratio. It is referred to as trim by the bow or head if the forward draught is the greater, level trim if both are the same and trim by the stern if the draught aft is the greater. If the ship has a designed initial trim (raked keel or drag) the trim is generally measured with respect to this initial longitudinal inclination.

**Trim** (*seakeeping, manoeuvring*)

The steady-state longitudinal angular position of a ship; to be distinguished from pitching, which is an oscillatory motion.

**Trim, angle of** (*seakeeping, manoeuvring*) ( $\theta$ ) [-]

The angle, measured about a horizontal axis, between the position of the longitudinal axis of a ship at rest and the horizontal plane.

**True wind direction or velocity**

See: *wind direction or velocity, true.*

**Tumblehome** (*ship geometry*)

The slant inward from the vertical of a transverse section of a hull above the designed waterline. It is the opposite of flare.

**Turning** (*manoeuvring*)

That phase of manoeuvring in which a body or ship while moving ahead or astern, changes course or direction. The beginning of a turn, starting with the initial deviation from the approach path, is known as the "entry" into the turn; the end of a turn terminating in a new straight course, is known as the "sortie". See Figure 7-1.

**Turning, steady** (*manoeuvring*)

That phase of the turning in which the rate of change of heading steadies to a constant value.

**Turtleback or turtleback deck** (*ship geometry*)

A form of weather deck with large camber which is rounded over at the sides in order to shed the water rapidly in heavy weather; also called *turtle deck*.

# U

**Unsteady or transient** (*general*),

These apply to a condition which is invariably dynamic, in which the motion of body or the flow of a liquid changes with time, with reference to an assumed set of axes.

**Unsteady cavities** (*cavitation*)

Attached cavities which alternately grow (resembling steady cavities at any instant) – extending downstream from the point of attachment and collapse (i.e. sudden reduction in length), presumably by cyclic filling by the re-entrant flow and subsequent re-evaporation.

# V

**Vapour cavitation number** (*cavitation*)

See: *Cavitation number, vapour.*

**Vapour pressure** (*general*),

The pressure of vapour in equilibrium with its liquid state. It is also called the saturated vapour pressure or vapour tension, which for a given substance depends only upon the temperature.

**Vaporous cavitation** (*cavitation*)

A *nucleus* (which see) that grows explosively (after reaching critical size) contains mostly vapour phase, the diffusion time being too short for any significant increase in gas volume. This process, which depends upon evaporation of the liquid into the growing bubble, is a true cavitation and is called *vaporous cavitation*. For such cavitation to occur, pressure below vapour pressure are required.

**Variable pitch** (*propulsion, propulsor*)

See: *Pitch, variable.*

**Velocity, induced** (*propulsion, propulsor*)

See: *Induced velocity (axial, tangential, and radial).*

**Velocity potential** (*hydrodynamics*)

See *Potential function.*

**Ventilated flow** (*cavitation*)

A ventilated flow is one in which a “cavity” is formed entirely with air (or other permanent gas).

**Ventilation** (*cavitation*)

Process by which a ventilated flow is formed and maintained. *Natural ventilation* is applied

to a ventilated flow which derives a continuous flow of gas by means of the pressure created by the flow itself, as from the free surface in the case of a surface piercing, ventilated strut. *Forced ventilation* is applied to a ventilated flow in which the permanent gas is continuously supplied into the cavity by auxiliary means such as a pump.

**Ventilation inception** (*cavitation*)

Ventilation inception is defined as the condition at which air (or permanent gas) is drawn into the low-pressure region in a non-cavitating flow, from an external source, as at the free surface of a liquid.

**Ventilation index** (*cavitation*)

The ratio of the volumetric air feed rate to the product of free stream velocity and an area proportional to the cavity cross sectional dimension or to some typical body dimension.

**Ventilated propeller** (*propulsion, propulsor*)

See: *Propeller Types.*

**Vertical-axis propeller** (*propulsion, propulsor*)

Synonymous with cycloidal propeller. See: *Propeller Types.*

**Virtual mass** (*seakeeping*)

The combined effect of the mass of the ship and added mass corresponding to the hydrodynamic forces in phase with and proportional to the acceleration. (See also: *Added mass.*)

**Viscosity coefficient of dynamic (general) ( $\mu$ )** [ $L^{-1} M T^{-1}$ ]\*,

The ratio of the shearing stress in a fluid to its rate of shear deformation. See also: *Resistance section*.

\* For standard values of fresh water and salt water at 15° C ( 59° F ) see: *Performance Section* under “Water standard fresh and salt”. For values over a range of temperature in S.I units see in “Metrication Ship Research and Design”, Paffett, J.A.H. Trans. RINA, 1971; for corresponding values in Imperial Unit see Proceedings 10th International Towing Tank Conference, London 1963 or National Physical Laboratory, Ship Division Report No. 81 (1966).

**Viscosity, coefficient of dynamic ( $\mu$ )** [ $L^{-1} M T^{-1}$ ] (*hydrodynamics*)

The quantity expressing the resistance of a fluid to internal shear; the ratio of tangential stress to rate of shear deformation in flow of an incompressible Newtonian fluid. For unidirectional shear flow:

$$\mu = \frac{\tau}{dU/dy}$$

**Viscosity, coefficient of kinematic (hydrodynamics) ( $\nu$ )** [ $L^{-1} M T^{-1}$ ]

The ratio of the coefficient of dynamic viscosity to the mass density of the fluid:

$$\nu = \frac{\mu}{\rho}$$

See also General Section under “*Liquid Properties and Physical Constants*”

**Volume loss (cavitation) ( $V_L$ )** [ $L^3$ ]

An alternative criterion to weight loss for assessing cavitation damage, often derived from weight loss by using the density of the specimen material.

**Vortex cavitation (cavitation)**

See: *Hub vortex cavitation*, *Tip vortex cavitation* and *Trailing vortex cavitation*.

# W

## **Wake (performance)**

The wake is a term used to describe the motion imparted to the water by the passage of the ship's hull. It is considered to be positive if its direction is the same as that of the ship.

## **Wake fraction (performance) ( $w$ , $w_F$ ) [-]**

The difference between the ship speed  $V$  and the speed of advance  $V_A$  is called the wake speed ( $V - V_A$ ). Froude expressed the wake speed at the position of the propeller as a fraction of the speed of advance, calling this ratio the wake fraction  $w_F$ , such that

$$w_F = \frac{V - V_A}{V_A} \text{ and } V_A = \frac{V}{1 + w_F}$$

Taylor expressed the wake speed at the position of the propeller as a fraction of the ship speed, such that

$$w = \frac{V - V_A}{V} \text{ and } V_A = V(1 - w).$$

## **Wake fraction, nominal (performance) [-]**

Wake fractions calculated from speed measured at the propeller position by Pitot tube, vane wheels, etc. in the absence of the propeller are called nominal wakes.

## **Wake fraction, torque (performance) ( $w_Q$ ) [-]**

A propeller will develop the same torque  $Q$  at the same revolutions per unit time,  $n$ , when working behind a hull advancing at speed  $V$  and in open water at a speed of advance  $V_A$ . The torque wake fraction will then be

$$w_Q = \frac{V - V_A}{V}$$

This depends on identity of torque.

## **Wake fraction, thrust (performance) ( $w_T$ ) [-]**

A propeller will develop the same thrust  $T$  at the same revolutions per unit time,  $n$ , when working behind a hull advancing at speed  $V$  and in open water at a speed of advance  $V_A$ .

The thrust wake fraction will then be

$$w_T = \frac{V - V_A}{V}$$

This depends on identity of thrust.

## **Wake, frictional (performance)**

The component of the wake which results from the frictional action of the water when moving along the solid surface of a body or ship.

## **Wake, potential (performance)**

The component of the wake due to the potential flow around a body or ship, with velocity and pressure relationship in accordance with Bernoulli's Theorem.

## **Wake, wave or orbital (performance)**

The component of the wake set up by the orbital motion in the waves created by a body or ship.

## **Wall nuclei (cavitation)**

The undissolved gas nuclei which may exist in equilibrium in the crevices of the boundary wall material.

## **Warp (propulsion, propulsor) () [-]**

Synonymous with skew angle.

## **Wash-back (propulsion, propulsor)**

See: *Set-back*.

**Wash-down** (*propulsion, propulsor*)

See: *Set-back*.

**Wash-up** (*propulsion, propulsor*)

See: *Set-back*.

**Water jet** (*propulsion, propulsor*)

A form of propulsion in which water is taken into hull of the ship by means of ducting and energy is imparted to the water with a pump. The water is then ejected astern through a nozzle.

**Waterline** (*ship geometry*)

This term is used to indicate:

- i. The intersection line of the free water surface with the moulded surface of a ship, either in still water or when it is surrounded by waves of its own making.
- ii. The intersection line of any selected plane, parallel to the baseplane, with the moulded surface of a ship. (See Figure 2-21)

The angle of the waterline at the bow in the horizontal plane neglecting local shape at stern is the *Angle of entrance*. This is generally designated as the *Half angle of entrance* ( $i_E$ ) [-] i.e. with respect to the centreplane - See Figure 2-21.

The angle of the waterline at the stern in the horizontal plane neglecting local shape of stern frame is the *Angle of the run*. This is generally designated as *Half angle of run* ( $i_R$ ) [-] i.e. with respect to the centreplane – See Figure 2-21.

**Figure 2-21: Waterline characteristics**

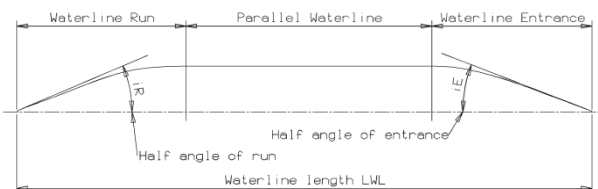

**Waterplane** (*ship geometry*)

Any selected plane through a ship from and a parallel to the baseplane, specifically:

**Designed Waterplane**, corresponding to the designed waterline.

**Maximum waterplane**, corresponding to the waterline of a ship at the draught at which the waterplane area is maximum.

**Waterplane area** (*ship geometry*) ( $A_W$ ) [ $L^2$ ]

The area enclosed by a waterline.

**Waterplane area coefficient, designed load** (*ship geometry*) ( $C_{WP}$ , formerly  $\alpha$ ) [-]

$$C_{WP} = A_W / LB_{WL}$$

where:

$L = L_{WL}$  = Length on the waterline

$B_{WL}$  = maximum breadth of the waterline.

**Waterplane inertia coefficients** (*ship geometry*)

**Longitudinal**  $C_{IL} = 12 I_L / BL^3$

**Transverse**  $C_{IT} = 12 I_T / B^3 L$

where:

$I_L$  = longitudinal second moment of area (or moment of inertia) of the waterplane.

$I_T$  = transverse second moment of area (or moment of inertia) of the waterplane.

**Water, restricted** (*performance*)

A term describing a body of water in which the boundaries are close enough to the ship to affect its resistance, speed, attitude, manoeuvring, and other performance characteristics, as compared with the corresponding characteristics in an open, unlimited, body of water. Principally, "restricted" applies to the proximity of the water boundaries in a horizontal direction.

**Water, shallow** (*performance*)

A term describing a body of water in which the boundaries are closed enough to the ship in a vertical direction to affect its resistance, speed, attitude, manoeuvring, or other performance characteristics as compared with its corresponding characteristics in water of unlimited depth.

**Water, standard fresh** (*performance*)

Water having zero salinity and a temperature of 15°C (59°F) with:

density  $\rho = 999.00 \text{ kg/m}^3$  (1.9384 lb s<sup>2</sup>/ft<sup>4</sup>.)

Kinematic viscosity  $\nu = 1.13902 * 10^{-6} \text{ m}^2/\text{s}$ .  
(1.22603 10<sup>-5</sup> ft<sup>2</sup>/s)\*

**Water, standard salt (performance)**

Water having 3.5 per cent salinity and a temperature of 15°C (59°F) with:

density  $\rho = 1,02587 \text{ Kg/m}^3$  (1.9905 lb s<sup>2</sup>/ft<sup>4</sup>)

Kinematic viscosity  $\nu = 1.18831 \cdot 10^{-6} \text{ m}^2/\text{s}$ .  
 (1.27908 \* 10<sup>-5</sup> ft<sup>2</sup>/s)\*

**Wave (hydrodynamics, seakeeping)**

A disturbance of the surface of a fluid that usually progresses across the surface as the result of circular or other local motions of the fluid components. A standing wave is special case of a wave that does not advance.

**Amplitude** ( $\zeta_A$ ) [L] - The radius of orbital motion of a surface wave particle, equal to one half of the wave height .

**Components** - The infinity of infinitesimal waves of different frequencies and directions which are found by spectral analysis to compose an irregular sea, or the large of finite wave used to approximate such an irregular sea.

**Direction, angle of** ( $\mu$ ) [-] - The angle between the direction of a component wave and the  $x_0$  axis.

**Encounter, angle of** ( $\mu$ ) [-] - The angle between the longitudinal axis of the ship and the direction of the wave encounter.

**Encounter, period** ( $T_E$ ) [T] - The time between successive crests of a train of waves passing a fixed point in a ship, at a fixed angle of encounter  $\mu$ ; the reciprocal of the frequency of encounter  $f_E$  (which see).

**Frequency** ( $f$ ) [T<sup>-1</sup>] The reciprocal of wave period =  $1/T$ , or circular frequency =  $2\pi/T$ .

**Height** ( $H_W$ ) [L] - The vertical distance from wave crest to wave trough, or twice the wave amplitude of a harmonic wave.

**Height, apparent** ( $H_{WV}$ ) [L] - The vertical distance between a successive crest and trough, estimated by visual observation.

**Height, significant** ( $H_{W1/3}$ )- The average apparent height of the 1/3 highest waves in an irregular pattern.

**Instantaneous elevation** ( $\eta$ ) [L] - The instantaneous elevation of a point in a wave system above the level of the undisturbed surface.

**Length** ( $L_W, \lambda$ ) [L] The horizontal distance between adjacent wave crests in the direction of advance.

**Length, apparent** ( $L_{WV}$ ) [L] - The horizontal distance between adjacent wave crests of an irregular sea in the direction of advance.

**Number** ( $\kappa$ ) [L<sup>-1</sup>]

$$\kappa = \frac{2\pi}{\lambda} \quad \text{or} \quad \frac{2\pi}{L_W}$$

**Period** ( $T_W$ ) [T] - The time between the passage of two successive wave crests passed a fixed point.

**Period, apparent** ( $T_{WV}$ ) [T] - The time elapsing between the occurrence of two successive crests of an irregular sea, or between two successive upward crossing of zero in a record, estimated by visual observation.

**Profile** - The elevation of the surface particles of a wave plotted as a function of space in a fixed time.

**Slope of surface** - The surface slope of a wave profile perpendicular to the crest in space co-ordinate. Maximum wave slope of a regular harmonic or trochoidal wave is  $\pi/2$  x steepness ratio.

**Speed celerity** ( $c_W$ ) [LT<sup>-1</sup>] - The phase velocity of a surface gravity wave in deep water.

$$c_W = \sqrt{\frac{gL_W}{2\pi}}$$

**Steepness ratio** - The ratio of wave height to length.

**Train** - A continuous sequence of wave crests and hollows.

**Trochoidal** - A profile closely approximating that of a regular surface gravity wave in a fluid; it can be geometrically constructed by tracing the path of a point on the radius of a circle as the circle rolls along the underside of a horizontal line.

**Wave, angle of diverging (hydrodynamics)**

The acute angle, measured in the horizontal plane, between axis of motion of a body and the normal to the crest or trough line.



**Wave encounter period** (*seakeeping*) ( $T_E$ ) [T]

The time between successive crests of a train of waves passing a fixed point in a ship, at a fixed angle of encounter  $\mu$ , the reciprocal of the frequency of encounter  $f_E$  (which see).

**Wavy surface** (*performance*)

See: *Surface, wavy*.

**Weight loss** (*cavitation*) ( $W_L$ ) [LMT<sup>-2</sup>]

Weight of material actually eroded from a specimen during a specified time while undergoing erosion damage. The most widely used measure of cavitation damage.

**Weathercock stability** (*manoeuvring*)

See: *Stability, weathercock*.

**Wetness** (*seakeeping*)

The quality of a part of the ship, usually the weatherdeck forward, with respect to its liability of being wet as a result of motions of ship and waves.

**Whipping** (*seakeeping*)

The transient ship-hull vibration which is induced by impulsive excitation forces. For example, fore-bottom slamming, bow-flare slamming, shipping of water and stern slamming. (See also: *Springing*).

**Wind, angle apparent** (*performance*) ( $\beta_{AW}$ ) [-]

The direction of the relative wind with respect to a ship's heading. The resultant direction of the wind induced by the ship's motion and the true wind, if any.

**Wind, angle true** (*performance*) ( $\beta_{TW}$ ) [-]

The direction of the wind, if any, with respect to a ship's heading.

**Wind direction** (*performance*) ( $\theta_W$ ) [-]

The direction of any natural or atmospheric wind blowing over the ground or over the surface of the sea, measured from the true North.

**Windmilling** (*propulsion, propulsor*)

The rotation of a propeller caused by flow past the propeller without power being applied to the propeller shaft. This action may take place while the ship is moving under its own momentum, while it is being towed, or while it is being propelled by other means of propulsion.

**Wind resistance** (*performance*)

See: *Resistance wind*.

**Wind velocity, relative** (*performance*) ( $V_{WR}$ ) [LT<sup>-1</sup>]

The velocity of the wind relative to the ship. It is the resultant of the wind induced by the ship's motion and the true wind, if any.

**Wind velocity, true** ( $V_{WT}$ ) [LT<sup>-1</sup>] (*performance*)

The velocity of a natural wind relative to the ground.

**Windward side** (*ship geometry*)

The side of a ship on which the wind blows. It is the opposite to the leeward side.

# X

# Y

**Yaw, angle ( $\chi$ ) [-]** (*performance, manoeuvring, seakeeping*) The angle, measured about the vertical body axis, between the instantaneous position of the longitudinal centreplane of a ship when *yawing* (which see) and its mean heading. (Positive bow to starboard).

**Yawing** (*manoeuvring, seakeeping*)  
The angular component of the oscillatory motion of a hull about a vertical axis.

# Z

**Zig Zag Manoeuvre, Zigzagging** (*manoeuvring*) A ship manoeuvre in which the course of a ship is deliberately changed at frequent intervals, as a deceptive or evasive manoeuvre, or as a trial manoeuvre, in accordance with a predetermined or specified plan, while the average course made good remains approximately the same as if the ship were not zigzagging. Standard manoeuvre for IMO manoeuvrability criteria. See Figure 7-10.

Figure 7-10: Zigzagging

